



User Guide

Receiver

R-N600A

musicCast 

TABLE OF CONTENTS

BEFORE USE 6

Please read first	6
About this product and manual	6
Input sources playable with this product	7
Compatible input sources	7
Compatibility with MusicCast	8
Accessories	9
Checking the accessories	9

NAMES OF PARTS AND THEIR FUNCTIONS 11

Unit	11
Front panel	11
Front display	14
Rear panel	16
Remote control	18
Remote control	18

PREPARATION 21

Preparing the remote control	21
How to insert batteries, and its operating range	21
Connecting external devices	22
Connecting audio devices	22
Connecting speakers	23
Connecting speakers	23
Making bi-wiring connections	26
Connecting a subwoofer	27
Connecting radio antennas	28
Connecting an FM antenna	28
Connecting an AM antenna	29
Connecting a DAB/FM antenna	30
Preparing a network connection	31
To make a network connection	31
Connecting a network cable (wired connection)	32
Preparing the wireless antenna (wireless connection)	33

Turning the product ON	34
Plugging the power cord into an outlet	34
Turning the power ON	35
Configuring MusicCast settings (connecting to a network)	37
Registering with the MusicCast network	37
PLAYBACK	38
Basic operations	38
Selecting the output speakers	38
Selecting an input source	39
Adjusting the volume	40
Switching the front display	41
Adjusting the sound to your preference	42
Enjoying Pure Direct playback (PURE DIRECT)	42
Adjusting bass and treble (BASS/TREBLE)	43
Adjusting left/right volume balance (BALANCE)	44
Making it easier to hear bass and treble at low volumes (LOUDNESS)	45
Listening to the radio	46
Preparing to listen to the radio	46
Selecting a radio station	49
Displaying the Radio Data System information	50
Displaying the DAB information	51
Auto-registering FM radio stations (auto preset)	52
Registering radio stations manually	53
Recalling a registered radio station	54
Removing the registration of a radio station	55
Playing via a Bluetooth® connection	56
Playing the audio of a Bluetooth device on this product (audio reception)	56
Playing this product's audio through Bluetooth speakers/headphones (audio transmission)	57
Listening to music via AirPlay	59
Playing music via AirPlay	59
Listening to internet radio	60
Selecting an internet radio station	60
Listening to streaming services	61
Listening to streaming services	61
Playing music on a USB device	62
Playing music on a USB device	62
Playing songs on media servers (PC/NAS)	64
Playing songs on media servers (PC/NAS)	64

Option menu (settings for each input source)	66
Basic operation of the Option menu	66
List of Option menu	67
Correcting volume difference between input sources	68
Displaying audio signal information	69
Performing an initial scan for DAB radio reception	70
Checking reception strength of each DAB channel label	71
Setting volume interlock with this product when playing an AirPlay/Bluetooth device	72
Setting auto playback	73

USEFUL FUNCTIONS **74**

Preset functions	74
Registering your favorite content to presets	74
Recalling content registered to a preset	76
Sleep timer function	77
Configuring the time for the sleep timer	77

SETTINGS **78**

Menus	78
Menu structure	78
Setup menu (changing function settings)	79
Basic operation of the Setup menu	79
List of Setup menu items	80
Configuring a network	81
Configuring Bluetooth	86
Configuring the volume	87
Configuring auto power standby	88
Setting the product to ECO mode	89
Advanced Setup menu (changing system settings)	90
Basic operation of the Advanced Setup menu	90
List of Advanced Setup menu items	91
Switching speaker impedance	92
Configuring the Remote ID	93
Changing the FM/AM tuning frequency setting	94
Initializing settings	95

UPDATING **96**

Checking the version of firmware	96
Checking the version of firmware	96

Updating the firmware	97
Updating the firmware	97
Updating the firmware via your network	98
Updating firmware via USB flash drive	99

TROUBLESHOOTING 101

If you think there is a problem	101
If you think there is a problem, the 1st step is checking the following	101
Problems with power, system, and/or remote control	102
Problems with the audio	104
Problems with FM radio	106
Problems with AM radio	107
Problems with DAB radio	108
Problems with USB	109
Problems with network	110
Problems with Bluetooth	113
Errors shown on the front display	114

APPENDIX 116

Product care	116
Taking care of this product	116
Making wireless network connections	117
Selecting the wireless method of connecting to the network	117
Using the WPS button to make a wireless connection	118
Making a wireless connection with your iPhone (WAC)	119
Making a wireless connection manually	120
Supported devices and formats	121
Supported Bluetooth devices	121
Supported USB devices	122
Supported file formats on this product (network/USB)	123
Trademarks	124
Trademarks	124
Specifications	125
Specifications	125

BEFORE USE

Please read first

About this product and manual

Thank you very much for purchasing this Yamaha product. This product is a network-compatible receiver for home use. It can play radio broadcasts and network content, as well as analog and digital audio input.

This manual (guide) is organized as follows. Please be sure to read each of the guides that came with the product and keep them handy for easy reference.

Safety Guide (Included with the Product)

Lists important safety precautions that should be read prior to use.

Quick Guide (Included with the Product)

This guide explains things from basic connections up through playing Internet radio.

User Guide (This Guide)

This provides explanations of all functions, such as information that is not addressed in the Quick Guide.

- The User Guide primarily explains operations using the included remote control.
- In the User Guide, iPhone, iPad, and iPod touch are referred to collectively as “iPhone”. Unless indicated within an explanation, references to “iPhone” mean iPhone, iPad, and iPod touch.
- Symbols used in the User Guide



- **CAUTION** is used with information about potential injuries.
- **NOTICE** is used with information for preventing product failure, damage or malfunction, and/or loss of data.
- **NOTE** is used with supplementary information that is helpful to know.
- [Search tag] are keywords for searching.

You can download the latest manuals from the following website.

<https://download.yamaha.com/>

Input sources playable with this product

Compatible input sources

As illustrated below, this product supports playing a variety of input sources.

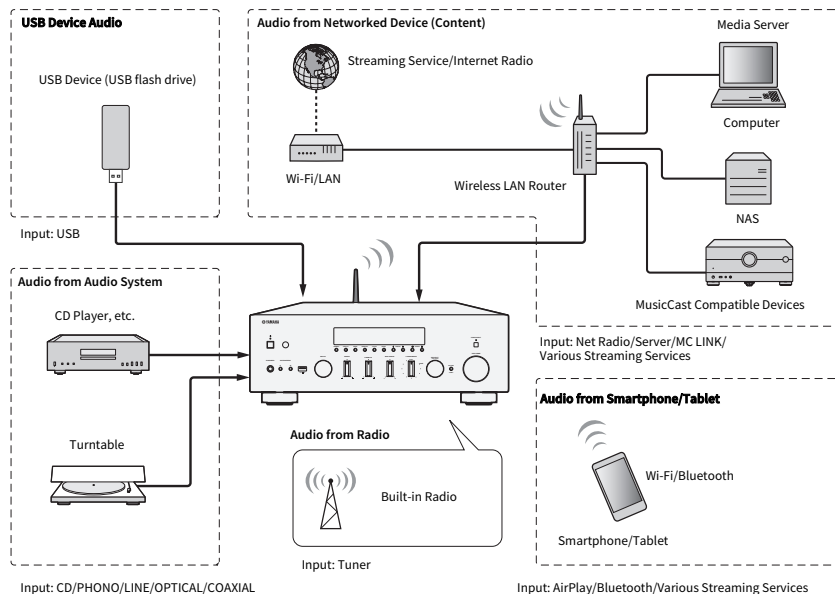

Related links (for connection)

- "Connecting external devices" (p.22)
- "Connecting radio antennas" (p.28)
- "To make a network connection" (p.31)

Related links (for playback)

- "Selecting an input source" (p.39)
- "Listening to the radio" (p.46)
- "Playing via a Bluetooth® connection" (p.56)
- "Listening to music via AirPlay" (p.59)
- "Listening to internet radio" (p.60)
- "Listening to streaming services" (p.61)
- "Playing music on a USB device" (p.62)
- "Playing songs on media servers (PC/NAS)" (p.64)

Compatibility with MusicCast



This product is compatible with MusicCast. This makes it possible to share music with MusicCast-compatible devices located in multiple rooms. Its dedicated app, “MusicCast Controller”, is easy to use and allows users to enjoy music from smartphones, media servers (PC/NAS), Internet radio and streaming services from anywhere in the home.

For details on MusicCast and compatible devices, please visit the Yamaha website. For more information about the app, search “MusicCast Controller” in the App Store or Google Play.

Accessories

Checking the accessories

This product comes with the following accessories. Check and make sure that you have all of the included accessories.

- DAB/FM antenna (Models for U.K., Europe, Russia and Australia)



- AM antenna (Models for U.S.A., Canada, China, Korea, Asia, Taiwan and for Central and South America)



- FM antenna (Models for U.S.A., Canada, China, Korea, Asia, Taiwan and for Central and South America)



* One of the above is supplied depending on the region of purchase.

- Remote control



- Batteries (AA, R6, UM-3) (×2)

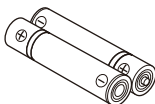

- Safety Guide

BEFORE USE > Accessories

Quick Guide

NAMES OF PARTS AND THEIR FUNCTIONS

Unit

Front panel

The following are the names of parts on the front of the unit and an explanation of their functions.

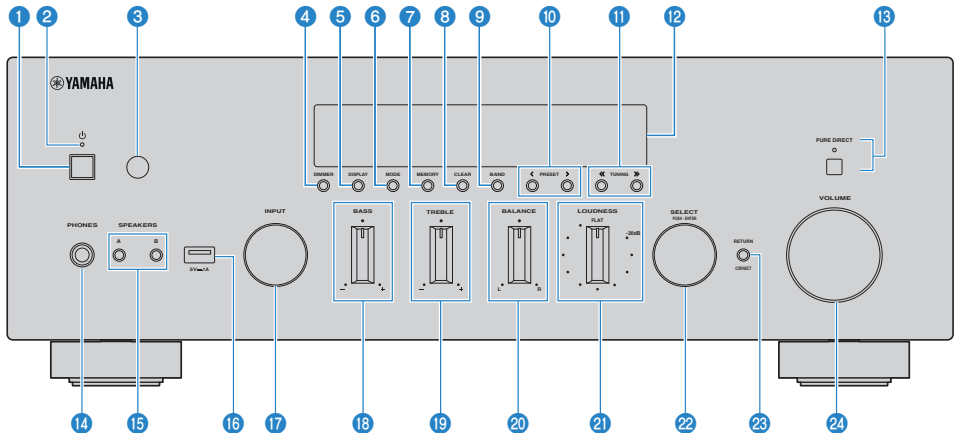

1 (Power) Switch

Turns this product ON (⏻)/OFF (⏷) (p.35).

With the power ON, press the ⏻ (Power) key on the remote control to switch the power between ON and Standby. This product also goes into Standby in the following situations.

- When the Auto Power Standby function is activated (p.88)

NOTE

The remote control does not work if the power is OFF. This product cannot also be linked with a Bluetooth device, a network device, or MusicCast Controller App.

2 Power Indicator

Lights up as follows to indicate the state of power.

Power ON: Indicator lights up.

Power in Standby: Indicator is faintly lit.

Power OFF: Indicator is off.

NOTE

When the indicator is flashing, it means the protective circuit has been activated and the power will not turn ON, in order to protect the product. Please contact an authorized Yamaha service center to have it repaired.

3 Remote control signal receiver

Receives the signal (infrared) from the remote control (p.21).

4 DIMMER

Changes the brightness of the front display. The brightness changes between 5 levels each time it is pressed.

5 DISPLAY

Switches the information shown on the front display panel (p.41).

6 MODE

Switches the FM Radio reception mode (Stereo/Mono) (p.49).

7 MEMORY

For registering radio stations (presets) (p.53). Internet radio stations, songs from media servers, and the song currently playing when USB input is selected can also be registered (p.74).

8 CLEAR

Removes a previously registered (preset) radio station (p.55).

9 BAND

Switches the radio tuner band (p.49).

10 PRESET

Used for recalling registered (preset) radio stations (p.54) and registered songs/Internet radio stations (p.76).

11 TUNING

Used for selecting a radio station (p.49).

12 Front Display

Displays various information and menus (p.14).

13 PURE DIRECT/Indicator

Switches the Pure Direct function ON/OFF (p.42). When this is ON, the indicator lights up, and the front display turns off.

14 PHONES jack

For plugging in headphones (compatible with standard stereo phone plugs).

NOTE

Audio cannot be output to speakers connected to this product when headphones are plugged in.

15 SPEAKERS A and B

For selecting the speakers to play from. Toggles Speakers A or B ON/OFF each time it is pressed (p.38).

16 USB port

For connecting a USB device (p.62).

17 INPUT

Selects the input source (p.39).

18 BASS

Adjusts the volume of the low-frequency range (p.43).

NAMES OF PARTS AND THEIR FUNCTIONS > Unit

19 **TREBLE**

Adjusts the volume of the high-frequency range (p.43).

20 **BALANCE**

Adjusts the left/right balance of the volume (p.44).

21 **LOUDNESS**

Adjusts to make it easier to hear bass and treble even at low volumes (p.45).

22 **SELECT (PUSH-ENTER)**

Used for things like operating the menus on the front display. Turn this to select an item, and press it to confirm the selection.

23 **RETURN/CONNECT**

Used for things like operating the menus on the front display.

Also used when registering this product on the MusicCast Network (p.37).

24 **VOLUME**

Adjusts the volume.

Related links

“Taking care of this product” (p.116)

Front display

The following is an explanation of what is shown on the front display.

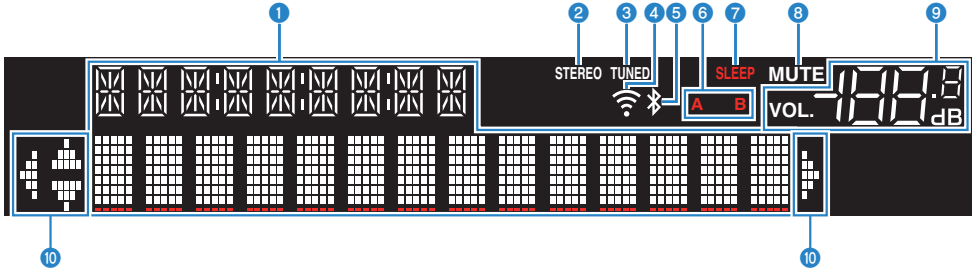

1 Information display

Various information is shown, such as the name of the input source.

Press DISPLAY on the front panel to switch the information shown (p.41).

NOTE

Only single-byte alphanumeric characters and some symbols are displayed.

2 STEREO indicator

Lights up when FM radio is received in stereo.

3 TUNED indicator

Lights up when a radio station is received.

4 Wireless LAN indicator

Lights up when the product is connected wirelessly to a network.

5 Bluetooth indicator

Lights up when connected to a Bluetooth device.

6 Speaker indicators

The indicator(s) of the speakers (A/B) from which audio is playing light up.

7 SLEEP indicator

Lights up when the sleep timer has been set (p.77).

8 MUTE indicator

Flashes when the audio is muted.

9 Volume indicator

Shows the volume setting of the product.

10 Cursor indicators

These light up when the cursor keys of the remote control can be used to control the product.

NOTE

- Pressing DIMMER on the front panel allows you to adjust the brightness of the front display (p.11).
- When using Pure Direct, the front display turns OFF. After turning OFF, the display comes back ON when the remote control or front panel is operated.

Rear panel

The following are the names of parts on the rear of the unit and an explanation of their functions.

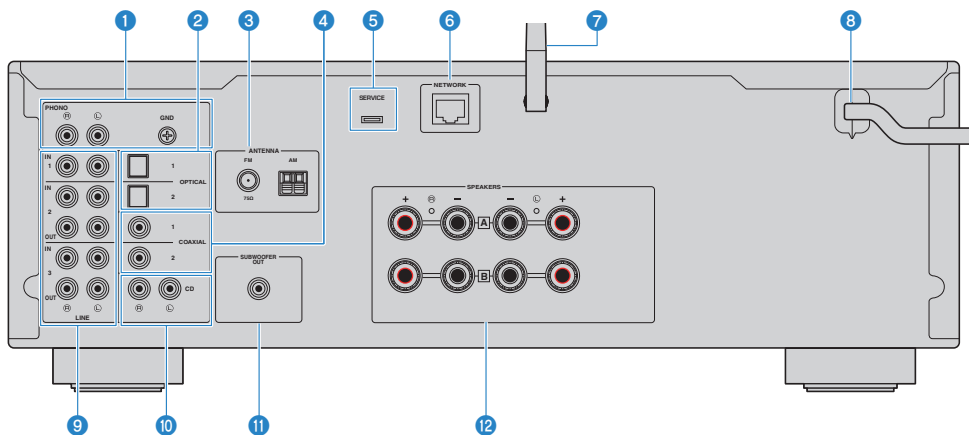

1 PHONO IN jacks

GND jack

For connecting to a turntable (p.22).

2 OPTICAL 1-2 IN jacks

For connecting to external devices with an optical digital output (p.22).

3 ANTENNA jack

For connecting to a radio antenna (p.28).

4 COAXIAL 1-2 IN jacks

For connecting to external devices with a coaxial digital output (p.22).

5 SERVICE port

These are service ports that are used when performing repairs, etc. Do not plug anything into them.

6 NETWORK jack

For connecting a network cable when connecting this product to a wired network (p.32).

7 Wireless antenna

For connecting this product to a wireless network (Wi-Fi) (p.33). It is also used for Bluetooth connections (p.56).

8 Power cord

Connects to an electrical outlet (p.34).

9 LINE 1-3 jacks

For connecting external devices that have analog audio inputs/outputs (p.22).

NAMES OF PARTS AND THEIR FUNCTIONS > Unit

10 **CD IN jacks**

For connecting to the analog audio OUT of devices like CD players (p.22).

11 **SUBWOOFER OUT jack**

For connecting to a subwoofer with a built-in amplifier (p.27).

12 **SPEAKERS jacks**

For connecting to speakers (p.23).

Remote control

Remote control

The following are the names of the parts of the remote control and explanations of their functions.

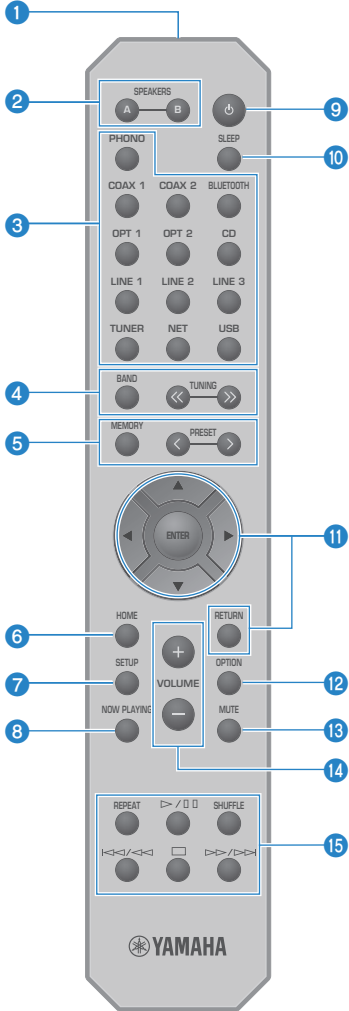

1 Remote control signal transmitter

Sends the remote control signal (infrared).

2 SPEAKERS A and B keys

For switching the output speakers. Toggles Speakers A or B ON/OFF each time it is pressed (p.38).

3 Input source selection keys

Selects the input source to play (p.39).

NOTE

Pressing the NET key repeatedly switches between the network sources.

4 BAND key

Switches the radio tuner band (p.49).

TUNING keys

Used for selecting a radio station (p.49).

5 MEMORY key

For registering radio stations (presets) (p.53). Internet radio stations, songs from media servers, and the song currently playing when USB input is selected can also be registered (p.74).

PRESET keys

Used for recalling registered (preset) radio stations (p.54) and registered songs/Internet radio stations (p.76).

6 HOME key

Moves to the top level when selecting music files, folders, etc.

7 SETUP key

Opens the Setup menu (p.79).

8 NOW PLAYING key

Displays song information when selecting music files, folders, etc.

9 (Power) key

Switches the power of this product between ON and Standby (p.35).

10 SLEEP key

Sets the sleep timer (p.77).

11 Menu operation keys

Cursor keys (▲▼◀▶), ENTER key, and RETURN key

For operating the menus.

12 OPTION key

Opens the Option menu (p.66).

13 MUTE key

Mutes the sound. Pressing it again returns the volume to its previous level.

14 VOLUME +/- keys

Adjusts the volume (p.40).

15 **Playback keys**

REPEAT key, ▶/■ (Play/Pause) key, SHUFFLE key, ⏮/⏪ (Skip/Rewind) key, ■ (Stop) key, ▶▶/▶▶ (Fast-Forward/Skip) key

For operating playback, such as a media server, Internet radio, or Bluetooth.

PREPARATION

Preparing the remote control

How to insert batteries, and its operating range

Put the included batteries into the remote control facing the correct way (+/-).

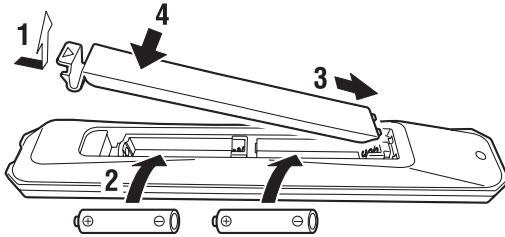

The operating range of the remote control is as illustrated.

Point the remote control at the remote control signal (infrared) receiver when operating it.

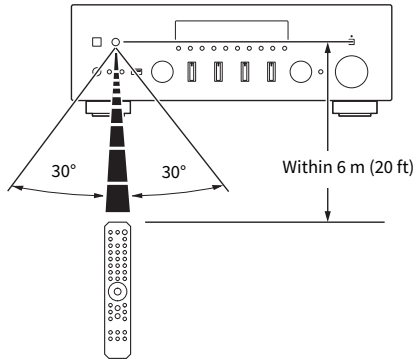

Connecting external devices

Connecting audio devices

This explains connecting audio devices, such as a CD player, to the product.

Use the type of cable appropriate for the jacks of the device to be connected, such as an RCA cable, optical fiber cable, or coaxial cable, which are commercially available.

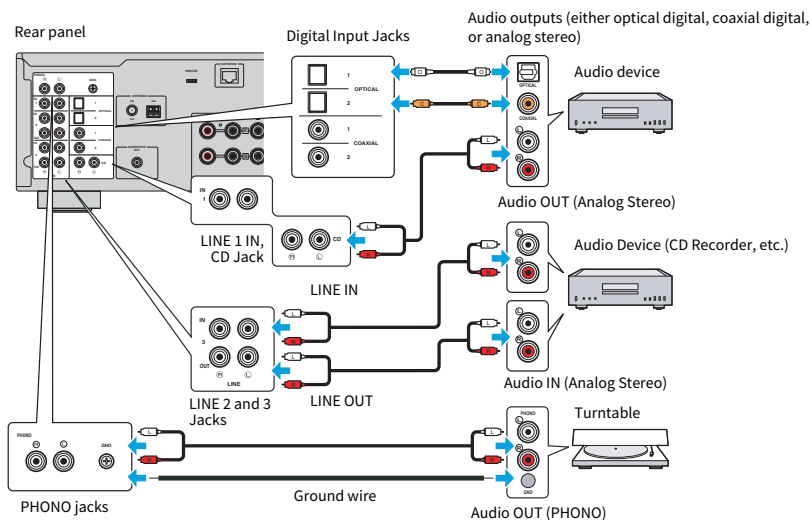

NOTE

- The digital inputs (OPTICAL/COAXIAL) of this product only support PCM signals (2-channel).
- The PHONO jacks of this product are compatible with MM cartridges. Use a step-up transformer or the like if connecting a turntable equipped with an MC (low-output) cartridge.
- For some turntables, connecting to the GND terminal of this product may reduce noise. However, there are also some turntables that have less noise if they are not connected to the GND jack.
- The GND terminal is not an electrical ground for safety purposes.

Related links

“Rear panel” (p.16)

Connecting speakers

Connecting speakers

Use speaker cable (commercially available) to connect speakers to the product.

NOTE

- Use the speakers with an impedance of at least 4-ohm.
- When connecting 2 sets of speakers (Speaker A and Speaker B), use the speakers with an impedance of at least 8-ohm.
- When connecting 4-ohm (4-ohm or more but less than 8-ohm) speakers, change the speaker impedance on the Advanced Setup menu.

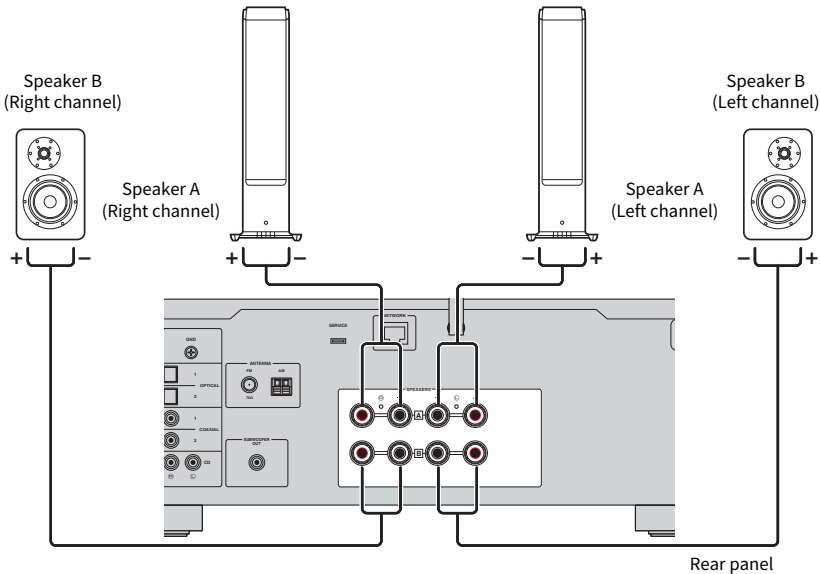

- 1** Peel off about 10 mm of insulation on the end of the speaker cable and twist its core tightly.

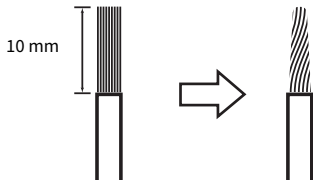

- 2 Turn the knob of the speaker jack to the left to loosen it, then insert the core of the speaker cable into the hole in the jack.**

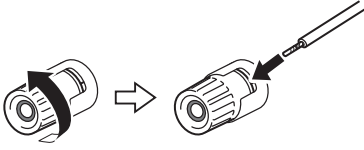

- 3 Turn the knob back to the right to tighten it.**



NOTICE

- When preparing the speaker cable, do so far away from the product. Pieces of the core wires of the speaker cable may fall inside the product and cause a short circuit, resulting in malfunction.
- Do not allow the core wires of a speaker cable to touch the core wires of another speaker cable or any metal parts of the product. Doing so may damage the product and/or the speakers.

NOTE

Be sure to connect to the jacks correctly: left channel (L), right channel (R) and + (red), - (black). If connected incorrectly, no audio may be output from the speakers. Also, if the polarity is wrong, the audio may sound strange.

■ Connecting via banana plug (Models for U.S.A., Canada, Australia, Taiwan and for Central and South America)

When using a banana plug, tighten the knob of the speaker jack and insert a banana plug into the end of the jack.

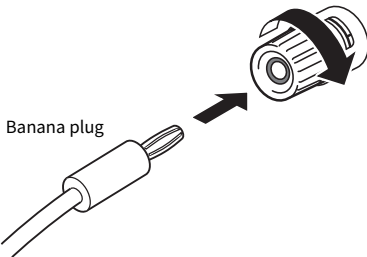

Related links

- “Making bi-wiring connections” (p.26)
- “Connecting a subwoofer” (p.27)
- “Switching speaker impedance” (p.92)

Making bi-wiring connections

Bi-wiring allows output to the speaker woofers (low frequency) and the tweeter/mid-range (mid to high-frequency) to be split and driven separately. Speakers compatible with bi-wiring are required for these connections.

1 Remove the short bar or bridge attached to the jacks of the speakers.

2 Connect the product and the speakers as illustrated.

The illustration shows connecting the left channel. Connect the right channel in the same way. Swapping the connections between speaker jacks A and B is OK.

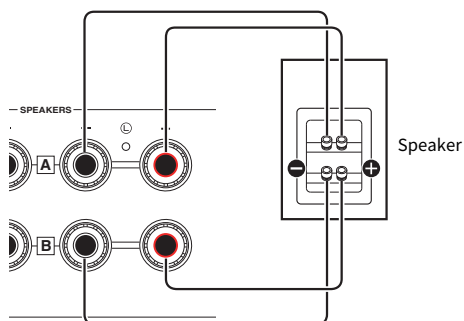

Rear panel

NOTE

- If the system is connected with bi-wiring, turn ON both Speakers A and B by pressing the SPEAKERS A and SPEAKERS B keys when the power is ON.
- Use speakers with an impedance of at least 4-ohm and that are compatible with bi-wiring connections.

Related links

[“Selecting the output speakers” \(p.38\)](#)

Connecting a subwoofer

To use a subwoofer, connect it to the product with a monaural pin cable (RCA) (commercially available).

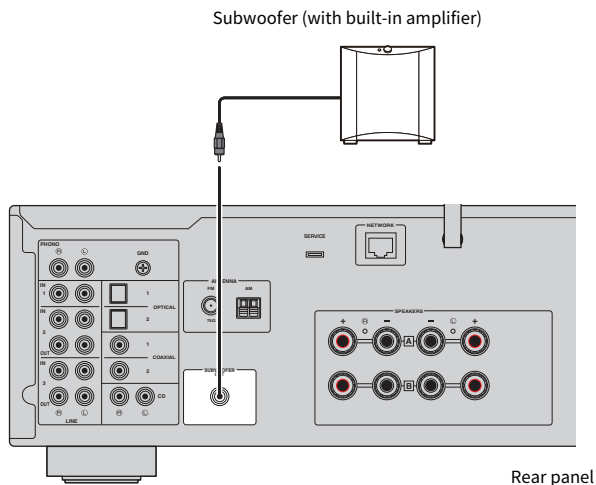

Connecting radio antennas

Connecting an FM antenna

Model For

U.S.A., Canada, China, Korea, Asia, Taiwan, Central and South America

Connect the included FM antenna to the product.

After connecting the FM antenna, secure it to a wall.

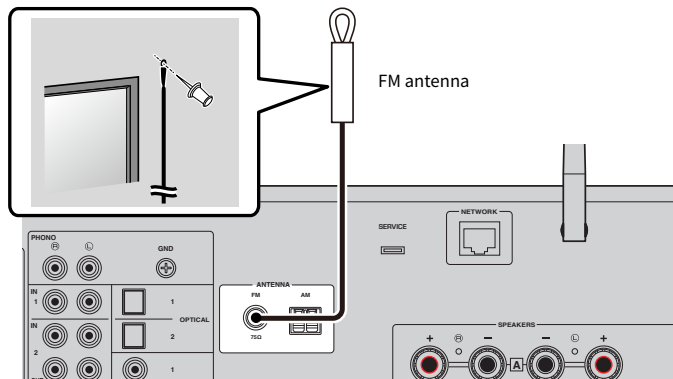

Rear panel

Connecting an AM antenna

Model For

U.S.A., Canada, China, Korea, Asia, Taiwan, Central and South America

Connect the included AM antenna to the product.

Put the AM antenna in a flat location after connecting it.

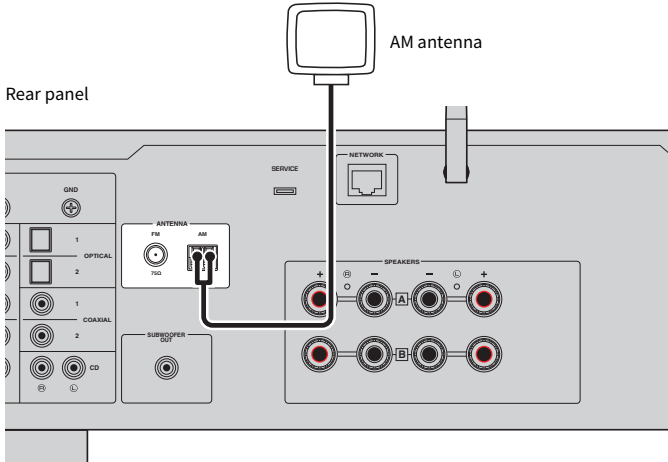

Assembly and connection of the AM antenna

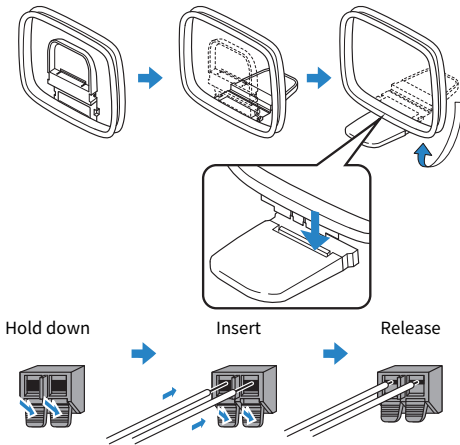

NOTE

- Only unwind as much wire from the antenna unit as is required for wiring.
- The cord of the AM antenna does not have polarity.

Connecting a DAB/FM antenna

Model For

U.K., Europe, Russia and Australia

Connect the included DAB/FM antenna to the product.

Fix the antenna ends to a wall.

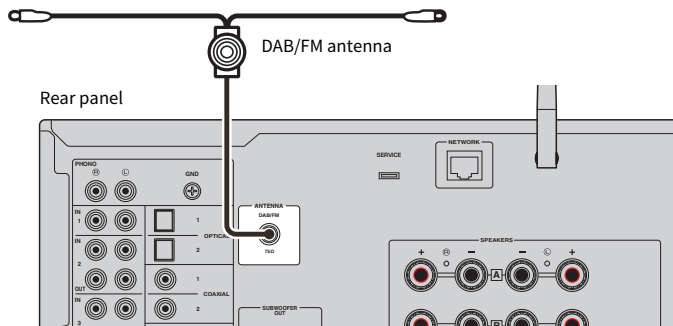

NOTE

- The antenna should be stretched out horizontally.
- If you cannot obtain good reception on the radio, adjust the height, direction or placement of the DAB/FM antenna.

Preparing a network connection

To make a network connection

This product supports both wired and wireless connections.

Select the connection method according to your network environment.

Connecting to a network allows you to play Internet radio stations and music files stored on media servers such as computers or network-attached storage (NAS).

NOTICE

- When connecting the product to the Internet, be sure to connect via a router to ensure security. Set up an appropriate password for the router that it goes through. Do not connect directly to communication lines (including public LANs) of telecommunications carriers (mobile communication companies, fixed-line providers, Internet providers, etc.)

Related links

- “Connecting a network cable (wired connection)” (p.32)
- “Preparing the wireless antenna (wireless connection)” (p.33)

Connecting a network cable (wired connection)

Use a network cable (CAT-5 or higher straight cable) (commercially available) to connect the product to the router.

If the router is compatible with DHCP servers, network settings do not have to be configured for this product.

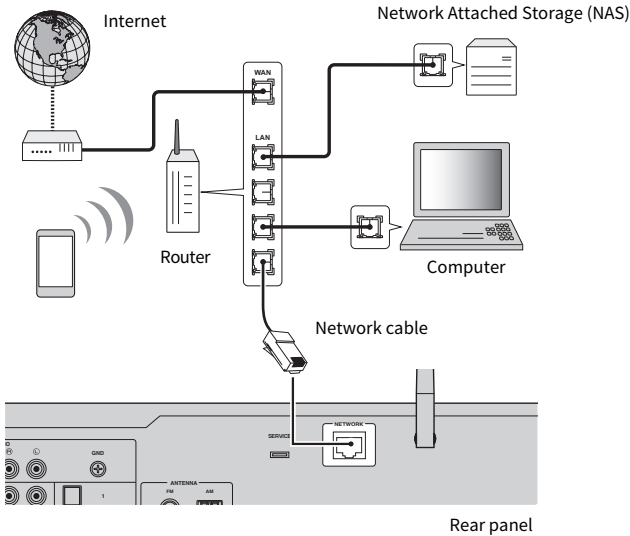

NOTE

- If the router is not compatible with DHCP servers, or if you want to configure the network parameters manually, you must configure the network settings.
- Use STP (Shielded Twisted Pair) cable to prevent electromagnetic interference.

Related links

“Configuring a network” (p.81)

Preparing the wireless antenna (wireless connection)

To use a wireless or Bluetooth connection, flip up the wireless antenna.

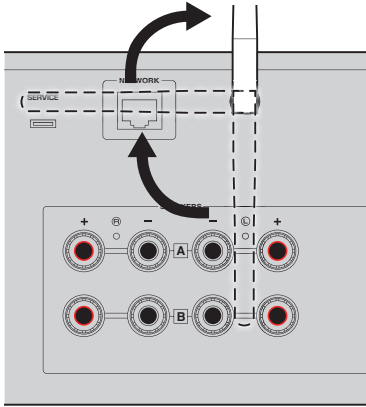

NOTICE

- When purchased, the wireless antenna is fixed with tape. Gently peel off the tape and flip up the wireless antenna as illustrated.
- Do not exert excessive force on the wireless antenna when you flip it up. Doing so may damage it.

Related links

- “Registering with the MusicCast network” (p.37)
- “Selecting the wireless method of connecting to the network” (p.117)

Turning the product ON

Plugging the power cord into an outlet

After making all the connections, connect the power cord to an outlet.

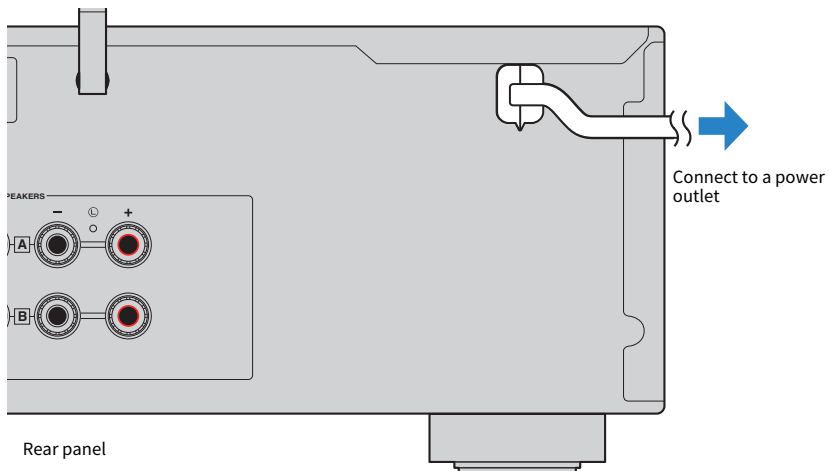

NOTE

Be sure to unplug this product from the power outlet when it will not be used for a long time. This product consumes a small amount of electricity even when its power is in Standby.

Turning the power ON

Turn the product ON.

1 Press the (Power) Switch on the front panel.

The power comes ON and the Power Indicator lights up.

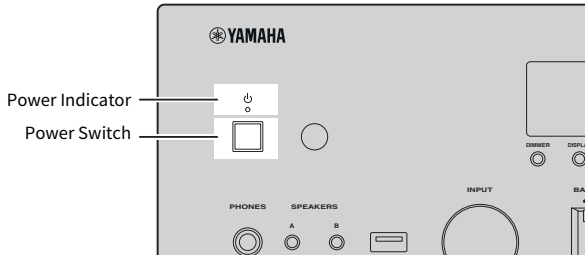

2 When the following message is shown on the front display, press RETURN on the front panel.

When you connect this product to the router with a network cable (wired connection), this operation is skipped.

It may take about 30 seconds for the message to be shown. The portion marked with “*” varies depending on the device.

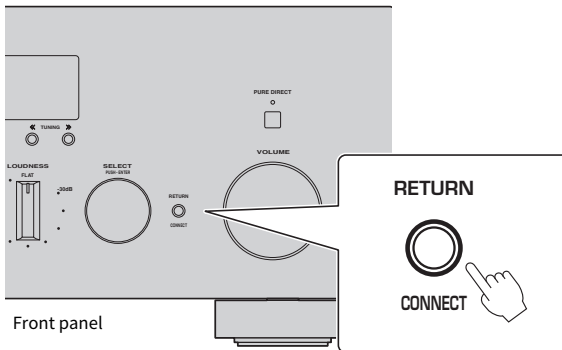

“WAC” Display

- The WAC (Wireless Accessory Configuration) function is for applying the wireless settings of an iOS device to another device and wirelessly connecting to the network. The steps for connecting to a network using MusicCast Controller are explained in the chapter “PREPARATION”. Therefore, how to cancel WAC is explained here.
- The WAC message is displayed the first time you use the product and after it is initialized.



NOTE

- It takes several seconds from turning the power ON until audio is played.
- After turning the power OFF, do not try to turn it ON again for at least 10 seconds. Doing so may generate some noise.

Related links

“Making a wireless connection with your iPhone (WAC)” (p.119)

■ Operating the power with the remote control

When the  (Power) Switch on the front panel is ON, the product switches between ON/Standby each time the  (Power) key on the remote control is pressed.

NOTE

When the product's power is in Standby, to turn the power ON without using the remote control, press the  (Power) Switch to turn it OFF momentarily, and then press it again to turn it ON again.

Configuring MusicCast settings (connecting to a network)

Registering with the MusicCast network

Register the product to the MusicCast network. You can configure network connection settings for the product at the same time. The dedicated app “MusicCast Controller” for mobile devices is required for making settings. Find “MusicCast Controller” (free) in the App Store or Google Play and install it.

- 1 Start “MusicCast Controller” on your mobile device(s) and tap “Setup”.**
- 2 Follow the instructions provided by “MusicCast Controller”.**

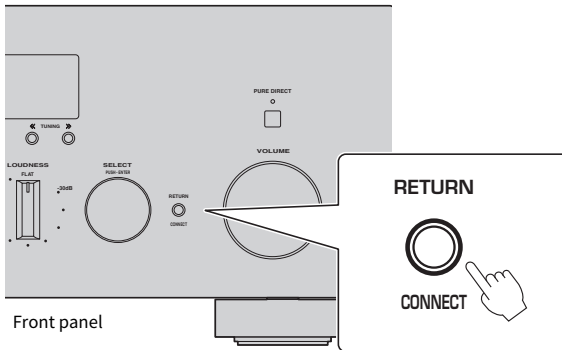

NOTE

- To connect to the network wirelessly, ensure that you have the SSID and security key of the wireless LAN router (access point) you wish to use.
- To configure a second and subsequent MusicCast-compatible devices, tap “Settings” > “Add New Device” in “MusicCast Controller”.

Related links

“Configuring a network” (p.81)

PLAYBACK

Basic operations

Selecting the output speakers

Press the SPEAKERS A key and/or SPEAKERS B key to select the speakers to output to. You can check which speakers are selected via the speaker indicator on the front display.

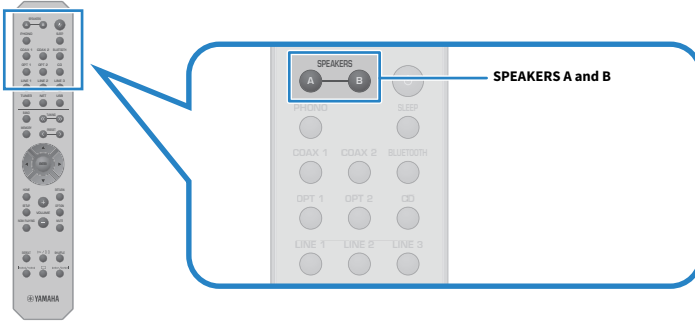

Each press of the SPEAKERS A or SPEAKERS B keys switches the corresponding speakers ON/OFF.

Speaker Indicators	Output Speakers
A	Outputs from Speakers A.
B	Outputs from Speakers B.
A B	Outputs from Speakers A and Speakers B.
	No output from either Speakers A or Speakers B.

NOTE

- You can also select the speakers by pressing SPEAKERS A or SPEAKERS B on the front panel.
- If the speakers are connected with bi-wiring, turn both Speakers A and Speakers B ON.
- When headphones are plugged in, audio cannot be output from speakers.

Selecting an input source

To play music, select the desired input source.

- 1 Turn ON an external device.**
- 2 Press an input source selection key to select an input source.**

Selects the input source from the following.

- PHONO key: turntable audio input via the PHONO input jacks
- COAX 1/2 keys: audio input via COAXIAL 1 or 2 input jack
- BLUETOOTH key: audio from a device, such as a smartphone, connected via Bluetooth.
- OPT 1/2 keys: audio input via OPTICAL 1 or 2 input jack
- CD key: audio input via CD input jacks
- LINE 1-3 keys: audio input via LINE 1, 2, or 3 input jacks
- TUNER key: audio from a radio station.
- NET key: audio input via the NETWORK jack or wirelessly.
- USB key: audio input via the USB port.

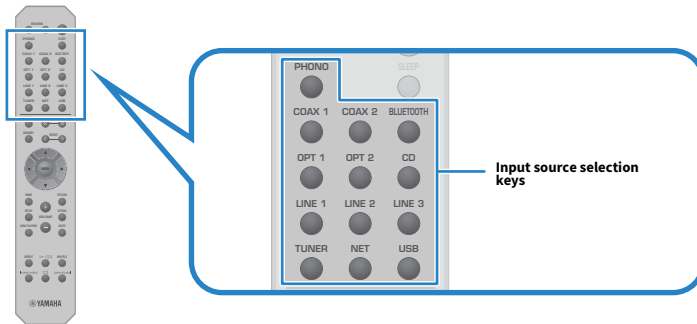

- 3 Operate an external device to start playback, or select a radio station with this product.**

NOTE

- You can also turn INPUT on the front panel to select the input source.
- For information on operating your external device, refer to its operating manual.

Adjusting the volume

Press the VOLUME +/- keys to adjust the volume.

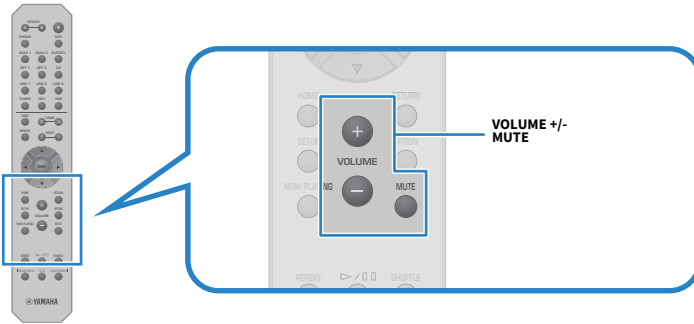

NOTE

- You can also turn VOLUME on the front panel to adjust it.
- Pressing the MUTE key mutes the sound. Pressing it again returns the volume to its previous level.
- You can adjust the sound to your preference with BASS, TREBLE, BALANCE and LOUDNESS on the front panel.

Related links

- “Adjusting bass and treble (BASS/TREBLE)” (p.43)
- “Adjusting left/right volume balance (BALANCE)” (p.44)
- “Making it easier to hear bass and treble at low volumes (LOUDNESS)” (p.45)

Switching the front display

The information shown on the front display can be changed depending on the current input source. Press DISPLAY on the front panel repeatedly to select the item you wish to display.



The selected information is displayed after 3 seconds.



The following display items are available.

Currently input source	Displayed item
TUNER (FM/AM)	Frequency
	(Models for U.K., Europe, and Russia) Radio Data System data is also available when this product is tuned into a Radio Data System broadcasting station. For details, see the following: <ul style="list-style-type: none"> • “Displaying the Radio Data System information” (p.50)
TUNER (DAB)	(Models for U.K., Europe, Russia, and Australia) For details, see the following: <ul style="list-style-type: none"> • “Displaying the DAB information” (p.51)
	Track, Artist, Album
Bluetooth Streaming services*	Track, Artist, Album, Time
Server	Track, Artist, Album, Time
AirPlay	Track, Artist, Album, Time
USB	Track, Artist, Album, Time
Net Radio	Track, Album, Time, Station

* The display can only be switched for some streaming services.

Adjusting the sound to your preference

Enjoying Pure Direct playback (PURE DIRECT)

Pure Direct stops various processes and circuitry except for the basic ones for playback, letting you enjoy higher quality sound with reduced noise.

After pressing PURE DIRECT to turn it ON, the PURE DIRECT indicator lights up.

NOTE

- When using Pure Direct, the following functions are disabled.
 - The various adjustment functions: BASS, TREBLE, BALANCE, and LOUDNESS
 - Operation of Option menu and Setup menu
 - Indications on the front display (when no operations performed)
- When using Pure Direct, transmissions to the MusicCast Network are not available, except the audio of network content and Bluetooth devices.

Adjusting bass and treble (BASS/TREBLE)

You can adjust the level of high-frequency range (Treble) and low-frequency range (Bass) individually.

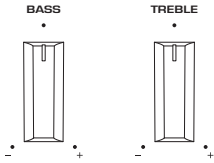

■ Adjusting the bass

When the bass feels too weak, turn BASS to the right to increase it. When it feels too strong, turn BASS to the left to reduce it.

It has flat characteristics when set to the middle.

Setting range: -10 dB to 0 to +10 dB (20 Hz)

■ Adjusting the treble

When the treble feels too weak, turn TREBLE to the right to increase it. When it feels too strong, turn TREBLE to the left to reduce it.

It has flat characteristics when set to the middle.

Setting range: -10 dB to 0 to +10 dB (20 kHz)

NOTE

When Pure Direct is used, the settings are disabled (left and right channels are fixed at 0 dB).

Adjusting left/right volume balance (BALANCE)

Any unbalance in volume due to positioning of the speakers and/or conditions in the room can be corrected by adjusting the balance of the volume between the left and right speakers.

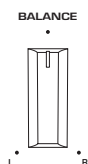

Turn BALANCE left or right to adjust the left channel (L) or the right channel (R). When turned all the way to the left or right, it mutes the opposite channel.

NOTE

When Pure Direct is used, the setting is disabled (left and right channels are fixed at 0 dB).

Making it easier to hear bass and treble at low volumes (LOUDNESS)

It lowers the volume of the midrange and allows the listener to enjoy natural sound even at low volumes by compensating for the human auditory characteristic that makes it difficult to hear bass and treble at low volumes.



CAUTION

- If Pure Direct is turned ON after adjusting the LOUDNESS, the input signal bypasses the loudness control function and the volume increases suddenly. To protect your ears and your speakers from damage, always check the state of LOUDNESS before turning ON Pure Direct. If it is set to any position other than FLAT, turn the volume down.

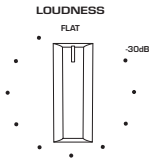

1 Put LOUDNESS to the FLAT position.

2 Turn VOLUME up to the maximum level at which you normally listen to music.

3 Turn LOUDNESS counterclockwise to a moderate volume.

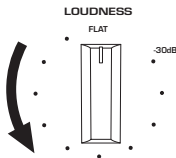

NOTE

- When Pure Direct is used, the settings are disabled (equivalent to the FLAT position).
- After making the settings, if the loudness effect is too strong (or weak) when played at your desired volume, adjust it again.

Listening to the radio

Preparing to listen to the radio





Setting the frequency steps

Model For

Asia, Taiwan, Central and South America

Set the radio tuning frequency steps of this product depending on your country or region.

At the factory, the frequency step setting is set to 50 kHz for FM and 9 kHz for AM. Depending on your country or region, set the frequency steps to 100 kHz for FM and 10 kHz for AM.

- 1 Push the  (Power) Switch on the front panel to turn the power OFF.**
- 2 While pressing RETURN on the front panel, push the  (Power) Switch.**
- 3 Turn SELECT on the front panel to choose “TU (Frequency Step)”.**
- 4 Press SELECT to choose “FM100/AM10”.**
- 5 Push the  (Power) Switch to turn it OFF.**
- 6 Push the  (Power) Switch again to turn it back ON.**

This completes the settings.

NOTE

Preset (registered radio stations) and frequency will be initialized if you change the radio tuning frequency steps.

Related links

[“Changing the FM/AM tuning frequency setting” \(p.94\)](#)

Preparing the DAB tuning

Model For

U.K., Europe, Russia and Australia

Before listening to DAB (Digital Audio Broadcasting) radio, perform an initial scan to register the DAB radio stations automatically.

- 1 Switch the input to “TUNER”.**
- 2 Press the BAND key to select the DAB band.**



After 3 seconds, the initial scan starts. When the initial scan finishes, this product automatically tunes in to the first DAB radio station in order by frequency.

NOTE

- DAB uses digital signals for clearer sound and more stable reception compared to analog signals. This product can also receive DAB+ (an upgraded version of DAB) that allows for more stations using MPEG-4 HE-AAC v2 audio codec, which has a more efficient transmission method.
- Be sure to check the DAB coverage in your area in that not all areas are currently being covered. For a list of nationwide DAB statuses and worldwide DAB frequencies, check WorldDMB online at <http://www.worlddab.org/>.
- If no DAB radio stations are found by an initial scan, the front display will change to “Off Air”.
- To perform an initial scan again after some DAB radio stations are stored, select “Init Scan (Initial Scan)” in the Option menu. If you perform an initial scan again, the DAB radio stations currently registered to the preset numbers will be cleared.
- You can check reception strength of each DAB channel label. Select “Tune AID” in the Option menu.

Related links

- “Checking reception strength of each DAB channel label” (p.71)
- “Performing an initial scan for DAB radio reception” (p.70)

■ DAB frequency information

This product supports Band III (174 to 240 MHz) only.

Frequency	Channel label
174.928 MHz	5A
176.640 MHz	5B
178.352 MHz	5C
180.064 MHz	5D
181.936 MHz	6A
183.648 MHz	6B
185.360 MHz	6C
187.072 MHz	6D
188.928 MHz	7A

PLAYBACK > Listening to the radio

Frequency	Channel label
190.640 MHz	7B
192.352 MHz	7C
194.064 MHz	7D
195.936 MHz	8A
197.648 MHz	8B
199.360 MHz	8C
201.072 MHz	8D
202.928 MHz	9A
204.640 MHz	9B
206.352 MHz	9C
208.064 MHz	9D
209.936 MHz	10A
211.648 MHz	10B
213.360 MHz	10C
215.072 MHz	10D
216.928 MHz	11A
218.640 MHz	11B
220.352 MHz	11C
222.064 MHz	11D
223.936 MHz	12A
225.648 MHz	12B
227.360 MHz	12C
229.072 MHz	12D
230.784 MHz	13A
232.496 MHz	13B
234.208 MHz	13C
235.776 MHz	13D
237.488 MHz	13E
239.200 MHz	13F

Selecting a radio station

You can use the this product's built-in tuner to listen to the radio.

1 Switch the input to “TUNER”.

2 Press the **BAND** key to switch to the next reception band.

- FM/AM (Models for U.S.A., Canada, China, Korea, Asia, Taiwan and for Central and South America)
- DAB/FM (Models for U.K., Europe, Russia and Australia)

3 Select a radio station.

- To specify a frequency to select a radio station, press the TUNING key repeatedly. You can also press and hold the TUNING key to automatically select a station.



The TUNED indicator lights up when a radio station is being received.

If in stereo, the STEREO indicator also lights up.

NOTE

The FM radio reception method (stereo or mono) can be switched by pressing MODE on the front panel repeatedly. When reception of an FM radio is unstable, it may help to switch to mono reception.

Related links

- “Auto-registering FM radio stations (auto preset)” (p.52)
- “Registering radio stations manually” (p.53)

Displaying the Radio Data System information

Model For

U.K., Europe and Russia

Radio Data System is a data transmission system used by FM stations. This product can receive various types of data, such as “Program Service”, “Program Type”, “Radio Text” and “Clock Time”, when it is tuned in to a Radio Data System broadcasting station.

- 1 Tune in to the desired Radio Data System broadcasting station.**
- 2 Press DISPLAY on the front panel to select between the various display items.**

The information appears on the front display.

Frequency	Frequency
Program Service	Program service name
Program Type	Current program type
Radio Text	Information on the current program
Clock Time	Current time

NOTE

- “—” is displayed in “Program Service”, “Program Type”, “Radio Text”, and “Clock Time” if the radio station does not provide the Radio Data System service.
- We recommend using “Auto Preset” to tune in to the Radio Data System broadcasting stations.

Related links

“Auto-registering FM radio stations (auto preset)” (p.52)

Displaying the DAB information

Model For

U.K., Europe, Russia and Australia

This product can receive various types of DAB information when it is tuned into a DAB radio station.

- 1 Tune in to the desired DAB radio station.**
- 2 Press DISPLAY on the front panel to select between the various display items.**

The information appears on the front display.



Service Label	Station name
Dynamic Label	Information on the current station
Ensemble Label	Ensemble name
Program Type	Station genre
Date And Time	Current date and time
Audio Mode	Audio mode (monaural/stereo) and bit rate
CH Label/Freq. (Frequency)	Channel label and frequency
Signal Quality	Signal reception quality (0 [none] to 100 [best])

NOTE

Some information may not be available depending on the selected DAB radio station, and “---” is displayed.

Auto-registering FM radio stations (auto preset)

This function automatically registers the FM stations with the strongest signal to preset numbers.

1 Switch the input to “TUNER”.

2 Press the OPTION key.

3 Select “Auto Preset” with the cursor keys (▲/▼) and then press the ENTER key.

To specify a preset number to start auto-presetting, use the PRESET or the cursor keys (▲/▼) to select the preset number within 5 seconds and then press the ENTER key.

Auto presetting begins and “SEARCHING” is shown during the auto preset process.

Once auto preset is complete, “FINISHED” is displayed and the Option menu closes automatically.

NOTE

- A maximum of 40 radio stations can be registered.
- To cancel auto preset, press the RETURN key.
- (Models for U.K., Europe and Russia) Only Radio Data System broadcasting stations are registered automatically by the Auto Preset function.

Related links

- “Selecting a radio station” (p.49)
- “Registering radio stations manually” (p.53)
- “Recalling a registered radio station” (p.54)

Registering radio stations manually

You can select a radio station and register it manually to a preset number.

1 Select a radio station.

2 Press the MEMORY key.



3 Select the preset number to register with the PRESET key.

4 Press the MEMORY key.



This completes the registration.

NOTE

- A maximum of 40 radio stations can be registered.
- To register a radio station to the next empty number from the previously preset number, press the MEMORY key for 3 seconds or so while on the desired radio station.
- To go back to the original display without registering, press the RETURN key.
- After 30 seconds of inactivity, the display automatically returns to the previous display.

Related links

- “Selecting a radio station” (p.49)
- “Auto-registering FM radio stations (auto preset)” (p.52)
- “Recalling a registered radio station” (p.54)

Recalling a registered radio station

This recalls a radio station (preset station) that is registered to preset number.

- 1 Switch the input to “TUNER”.**
- 2 Press the PRESET key to select the preset number.**

The registered radio station is recalled.

NOTE

- Any preset numbers without anything registered are skipped.
- If no radio stations are registered, “No Presets” is shown on the front display.

Removing the registration of a radio station

This explains how to remove the registration of a preset radio station.

- 1 Switch the input to “TUNER”.**
- 2 Press the OPTION key.**
- 3 Select “Clear Preset” with the cursor keys (▲/▼) and then press the ENTER key.**
- 4 Use the PRESET key or cursor keys (▲/▼) to select the preset number to be removed and then press the ENTER key.**

Once the registration is removed, “Cleared” is displayed and the next registered preset number is displayed.
- 5 To remove another preset number, repeat step 4.**
- 6 Press the OPTION key.**

This completes removal of the registration.

NOTE

Registered radio stations (preset stations) can also be removed using the front panel. Press CLEAR on the front panel and then use PRESET to select the preset number you wish to remove. Next press SELECT or CLEAR to remove the preset.

Playing via a Bluetooth® connection

Playing the audio of a Bluetooth device on this product (audio reception)

This product can play music files and the like saved on a Bluetooth device (such as a smartphone).



CAUTION

- If you adjust the volume on the Bluetooth device, it may get unexpectedly loud and cause damage to your hearing and/or equipment. If the volume becomes too loud during playback, stop playback immediately.

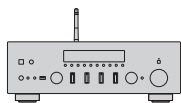

This product



Bluetooth device
(smartphone, etc.)

- 1 Switch the input to “Bluetooth”.**
- 2 Select this product (network name of this product) on the Bluetooth device.**
If a passkey is required, enter the number “0000”.
- 3 Play the audio of the Bluetooth device.**

NOTE

- If a paired Bluetooth device is detected, the input switches and the device is connected automatically. To connect to a different Bluetooth device, first disconnect the current connection.
- You can use the ►/■ (Play/Pause) key and ■ (Stop) key to control playback of your Bluetooth device.
- The volume on this product can be controlled from the Bluetooth device while it is playing.
- To disconnect the Bluetooth device, do any of the following.
 - Perform a disconnect operation on the Bluetooth device.
 - Press the BLUETOOTH key for 3 seconds (it may take some time to disconnect).
 - Switch the input of this product to anything other than “Bluetooth”.
 - Switch “Bluetooth” on the Setup menu to “Off”.
- The Bluetooth indicator on the front display lights up when a Bluetooth device is connected.
- Repeatedly pressing DISPLAY on the front panel during playback allows you to switch the playback information shown on the front display.

Related links

- “Configuring Bluetooth” (p.86)
- “Setting volume interlock with this product when playing an AirPlay/Bluetooth device” (p.72)
- “Switching the front display” (p.41)

Playing this product's audio through Bluetooth speakers/headphones (audio transmission)

You can output the audio playing on this product to Bluetooth speakers/headphones.

Only connect to Bluetooth speakers/headphones that have volume adjustment. This product cannot adjust their volume.

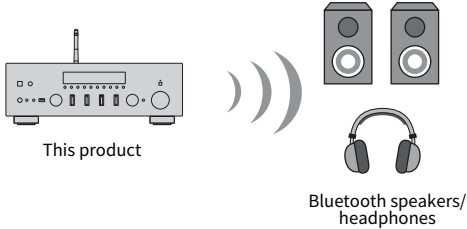

- 1 Select an input other than “Bluetooth”.**
- 2 Put the Bluetooth speakers/headphones that you wish to connect into pairing mode.**
- 3 Select the input source with the MusicCast Controller app.**
- 4 Tap the Settings icon on the playback screen.**
- 5 Tap “Bluetooth Transmission” on the Sound Settings screen.**
- 6 Turn “Bluetooth transmission” on from the Bluetooth Transmission settings screen.**
- 7 Select the Bluetooth speakers/headphones to send to.**

Once the connection is complete, audio is output from the Bluetooth speakers/headphones.

NOTE

- Adjust the volume on the connected Bluetooth device.
- The audio being played is also output from the speakers connected to this product.
- AirPlay, DSD, and PCM audio exceeding 192 kHz cannot be transmitted.
- When using Pure Direct, audio of input sources other than network content cannot be transmitted.
- Audio cannot be sent and received at the same time via the Bluetooth function.
- To disconnect the Bluetooth device, do any of the following.
 - Perform a disconnect operation on the Bluetooth device.
 - Switch the input of this product to “Bluetooth”.
 - Switch “Bluetooth” on the Setup menu to “Off”.
- The Bluetooth indicator on the front display lights up when a Bluetooth device is connected.

PLAYBACK > Playing via a Bluetooth® connection

Related links

[“Configuring Bluetooth” \(p.86\)](#)

Listening to music via AirPlay

Playing music via AirPlay

You can play music and other content on this product via AirPlay. Tap (or click) the AirPlay icon on your iPhone or iTunes/Music and then select this product as the output destination.



CAUTION

- The volume may become louder than expected when adjusting it on your AirPlay device, which can cause damage to your hearing and/or your device. If the volume becomes too loud during playback, stop playback immediately.

Explanation of key operations: playback keys

- ▶/■ (Play/Pause) key: starts or pauses playback.
- ■ (Stop) key: stops playback.
- ◀◀/▶▶ (Skip) or the ▶▶/▶▶ (Skip) keys: Use to skip to the beginning of the current song or to the beginning of the next.
- REPEAT key: changes the playback mode to Repeat.
- SHUFFLE key: changes the playback mode to Shuffle.

Explanation of key operations: playback info

- DISPLAY (Front Panel): Pressing repeatedly during playback allows you to switch the playback information shown on the front display.

NOTE

- You can set this product to turn ON automatically when your AirPlay device starts playing.
- You can change the network name of this product that is displayed on your AirPlay device.
- You can control the volume of this product from your AirPlay device during playback.
- The product is compatible with AirPlay 2.
- For information about AirPlay, see Apple's official website.
- AirPlay audio cannot be transmitted to the MusicCast Network.

Related links

- "Configuring a network" (p.81)
- "Setting volume interlock with this product when playing an AirPlay/Bluetooth device" (p.72)
- "Switching the front display" (p.41)

Listening to internet radio

Selecting an internet radio station

When this product is connected to a network, you can select and play Internet radio stations.

1 Press the NET key on the remote control repeatedly to switch the input to “Net Radio”.

2 Select the content with the cursor keys and press the ENTER key.

It starts playing.

Explanation of key operations: playback keys

- ▶/■ (Play/Pause) key: starts playback (cannot pause).
- (Stop) key: stops playback.

Explanation of key operations: playback info

- NOW PLAYING key: shows playback information for the Internet radio station on the front display.
- DISPLAY (Front Panel): Pressing repeatedly during playback allows you to switch the playback information shown on the front display.

Explanation of key operations: content-related

- Cursor keys: Use to select categories, such as Internet radio station or genres.
- ENTER key: Press when an Internet radio station is selected to start playing it. When a category is selected, press to move down one level.
- RETURN key: displays one level up.
- HOME key: displays the very top level.

NOTE

- You can register your favorite content to presets and then recall it easily.
- Some Internet radio stations may not be available at all times.
- This function uses the airable.Radio service. airable is a service provided by the company airable GmbH. This service is subject to change, suspension, or termination without notice. Please note that the Yamaha Corporation is in no way responsible for this.

Related links

- “To make a network connection” (p.31)
- “Registering your favorite content to presets” (p.74)
- “Switching the front display” (p.41)

Listening to streaming services

Listening to streaming services

When this product is connected to a network, you can play content distributed by the various streaming services.

For information on supported streaming services, go to the product information pages of the Yamaha website or refer to the MusicCast Controller.

The following website also provides supplementary information about different streaming services.

<https://manual.yamaha.com/av/mc/ss/>

NOTE

- Some streaming services require a subscription to their paid services. For details on each service provider, see its official website.
- Streaming services are subject to change, suspension, or termination without notice. Please note that the Yamaha Corporation is in no way responsible for this.

Related links

- “Configuring a network” (p.81)
- “Registering with the MusicCast network” (p.37)

Playing music on a USB device

Playing music on a USB device

This explains how to play music files saved on a USB device on this product.

Front panel

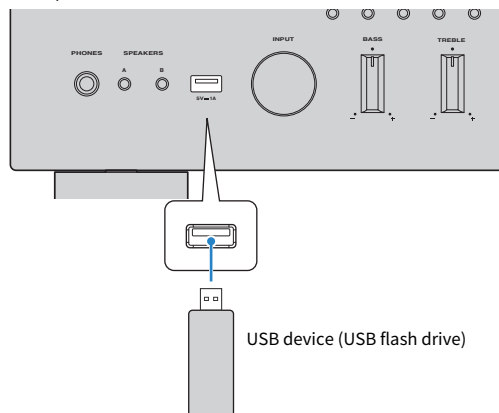

1 Plug the USB device into the USB port.

2 Switch the input to “USB”.



3 Select the content with the cursor keys and press the ENTER key.

Once you select a song, it starts playing.

Explanation of key operations: playback keys

- ▶/■ (Play/Pause) key: starts or pauses playback.
- ■ (Stop) key: stops playback.
- ◀◀/▶▶ (Skip) or the ▶▶/▶▶ (Skip) keys: Use to skip to the beginning of the current song or to the beginning of the next.
- REPEAT key: changes the playback mode to Repeat. Check the settings on the front display.
 - Off: disables Repeat mode.
 - One: plays the current song repeatedly.
 - All: plays all the songs on the album (or in the folder) repeatedly.

PLAYBACK > Playing music on a USB device

- SHUFFLE key: changes the playback mode to Shuffle. Check the settings on the front display.
 - Off: disables Shuffle mode.
 - On: plays all the songs on the album (or in the folder) in random order.

Explanation of key operations: playback info

- NOW PLAYING key: shows playback information on the front display for the song that is playing.
- DISPLAY (Front Panel): Pressing repeatedly during playback allows you to switch the playback information shown on the front display.

Explanation of key operations: content-related

- Cursor keys: for selecting music files, folders, etc.
- ENTER key: press when a folder is selected to move one level down. Press when a music files is selected to start playing it.
- RETURN key: displays one level up.
- HOME key: displays the very top level.

NOTE

- When there are a lot of files, it may take time to load them. In such case, "Loading..." is shown on the front display.
- Some text characters may not be available, and "." is displayed.
- Up to 500 songs can be played. The maximum number of songs may be lower, depending on the folder structure.
- Take care to stop playback before removing the USB device.
- USB devices should be connected directly to the USB port of the product. Do not use extension cables, etc.
- Power is not supplied to the USB device while the product is in standby. The USB port is not for charging devices.
- You can register your favorite content to presets and then recall it easily.
- When a USB device is connected to this product for the first time, the first song in the uppermost folder (root folder) is played automatically.

Related links

- "Supported USB devices" (p.122)
- "Supported file formats on this product (network/USB)" (p.123)
- "Setting auto playback" (p.73)
- "Switching the front display" (p.41)
- "Registering your favorite content to presets" (p.74)

Playing songs on media servers (PC/NAS)

Playing songs on media servers (PC/NAS)

When this product is connected to a network, it can play music files saved on a media server connected to the same server.

NOTE

It is necessary to enable the media sharing setting on each device or media server software ahead of time. For more details, refer to the user's manual of each device and software.

- 1 Press the NET key on the remote control repeatedly to switch the input to "Server".**



- 2 Select a media server with the cursor keys and then press the ENTER key.**
- 3 Select the content with the cursor keys and press the ENTER key.**

Once you select a song, it starts playing.

Explanation of key operations: playback keys

- ▶/■ (Play/Pause) key: starts or pauses playback.
- (Stop) key: stops playback.
- ◀◀/▶▶ (Skip) or the ▶▶/▶▶▶ (Skip) keys: Use to skip to the beginning of the current song or to the beginning of the next.
- REPEAT key: changes the playback mode to Repeat. Check the settings on the front display.
 - Off: disables Repeat mode.
 - One: plays the current song repeatedly.
 - All: plays all the songs on the album (or in the folder) repeatedly.
- SHUFFLE key: changes the playback mode to Shuffle. Check the settings on the front display.
 - Off: disables Shuffle mode.
 - On: plays all the songs on the album (or in the folder) in random order.

Explanation of key operations: playback info

- NOW PLAYING key: shows playback information on the front display for the song that is playing.
- DISPLAY (Front Panel): Pressing repeatedly during playback allows you to switch the playback information shown on the front display.

Explanation of key operations: content-related

- Cursor keys: for selecting music files, folders, etc.

PLAYBACK > Playing songs on media servers (PC/NAS)

- ENTER key: press when a folder is selected to move one level down. Press when a music files is selected to start playing it.
- RETURN key: displays one level up.
- HOME key: displays the very top level.

NOTE

- You can configure it so this product turns ON automatically when you start playing music on the media server.
- If the audio is cut off when connected to a wireless network, connect to a wired network.
- Playback can be controlled from a digital media controller (DMC).
- You can register your favorite content to presets and then recall it easily.

Related links

- “Setting auto playback” (p.73)
- “Configuring a network” (p.81)
- “Registering your favorite content to presets” (p.74)
- “Supported file formats on this product (network/USB)” (p.123)
- “Switching the front display” (p.41)

Option menu (settings for each input source)

Basic operation of the Option menu

You can set playback-related functions to suit the source that is currently playing. The basic operating methods of the Option menu are as follows.

1 Press the OPTION key.



2 Use the cursor keys (▲/▼) to select an item and press the ENTER key.

To go back a level of the menu, press the RETURN key.

3 Select the desired setting with the cursor keys (◀/▶).

4 Press the OPTION key.

This completes the configuration.

Related links

- “Menu structure” (p.78)
- “List of Option menu” (p.67)

List of Option menu

The following settings are available in the Option menu.

Item		Page
Volume Trim	In. Trim (Input Trim)	68
Signal Info.	FORMAT	69
	SAMPLING	69
Auto Preset		52
Clear Preset		55
Init Scan (Initial Scan)		70
Tune AID		71
Vol. Interlock (Volume Interlock)		72
Auto Playback		73

NOTE

The settings available on the Option menu vary with the input source. Only the items that can be configured are shown on the front display.

PLAYBACK > Option menu (settings for each input source)

Correcting volume difference between input sources

You can correct volume difference between input sources. If it bothers you when the volume becomes louder/quieter when you change the input source, use this setting to fine tune them.

Option menu

“Volume Trim” > “In. Trim (Input Trim)”

Setting value

-10.0 dB to +10.0 dB (0.5 dB intervals)

Default value

0.0 dB

NOTE

Each input source can be set individually.

Related links

“Basic operation of the Option menu” (p.66)

Displaying audio signal information

■ Displaying format information

You can display format information for the audio signal that is playing.

Option menu

“Signal Info.” > “FORMAT”

Related links

“Basic operation of the Option menu” (p.66)

■ Displaying the sampling frequency

You can display the sampling frequency of the audio signal that is playing.

Option menu

“Signal Info.” > “SAMPLING”

Related links

“Basic operation of the Option menu” (p.66)

Performing an initial scan for DAB radio reception

Model For

U.K., Europe, Russia and Australia

Performs an initial scan for searching DAB radio stations.

Option menu

“Init Scan (Initial Scan)”

- 1 Select “TUNER” as the input source.**
- 2 Press the BAND key to select the DAB band.**
- 3 Press the OPTION key.**
- 4 Use the cursor keys to select “Init Scan (Initial Scan)” and press the ENTER key.**
- 5 Press the ENTER key to start an initial scan.**

When the initial scan finishes, this product automatically tunes in to the first DAB radio station in order by frequency.

NOTE

- If you perform an initial scan again, the DAB radio stations currently registered to the preset numbers will be cleared.
- If no DAB radio stations are found by an initial scan, press the ENTER key to start an initial scan again.

Related links

“Basic operation of the Option menu” (p.66)

Checking reception strength of each DAB channel label

Model For

U.K., Europe, Russia and Australia

You can check reception strength of each DAB channel label.

Option menu

“Tune AID”

- 1 Select “TUNER” as the input source.**
- 2 Press the BAND key to select the DAB band.**
- 3 Press the OPTION key.**
- 4 Use the cursor keys to select “Tune AID” and press the ENTER key.**
- 5 Use the cursor keys to select the desired DAB channel label.**

The reception strength of DAB channel label is displayed in 0 (none) to 100 (best).

- 6 Press the OPTION key.**

This completes the checking.

Related links

“Basic operation of the Option menu” (p.66)

Setting volume interlock with this product when playing an AirPlay/Bluetooth device

When selecting an AirPlay/Bluetooth input, you can set whether to link the volume with this product. If set to anything other than Off, the volume of this product can be adjusted by the AirPlay or Bluetooth device.

Option menu

“Vol. Interlock (Volume Interlock)”

Setting value

Off	Disables volume control from AirPlay and Bluetooth devices.
Ltd	Enables volume control to mute and within the range of -96.5 to -40.0 dB.
Full	Enables volume control to mute and within the range of -96.5 to 0.0 dB.

Default value

Ltd

NOTE

Volume interlock is not available on all Bluetooth devices.

Related links

“Basic operation of the Option menu” (p.66)

Setting auto playback

This function sets whether or not to play the content on media servers and USB devices automatically.

Option menu

“Auto Playback”

Setting value

Off	Disables auto playback.
On	When the power is turned ON or the input is switched, the content that was last played starts playing automatically.

Default value

On

NOTE

- Auto playback can only be set if the input is “Server” or “USB”.
- Auto playback may not work with some inputs or content.

Related links

“Basic operation of the Option menu” (p.66)

USEFUL FUNCTIONS

Preset functions

Registering your favorite content to presets

You can easily recall your favorite content later (such as music on media servers or USB devices, or Internet radio stations) by registering it as presets.

■ Preset registration

Content that can be registered includes “TUNER”, “Server”, “Net Radio”, “USB”, and some streaming services.

- 1 Select the radio stations you want to register, or play songs or Internet radio stations.**
- 2 Press the MEMORY key.**

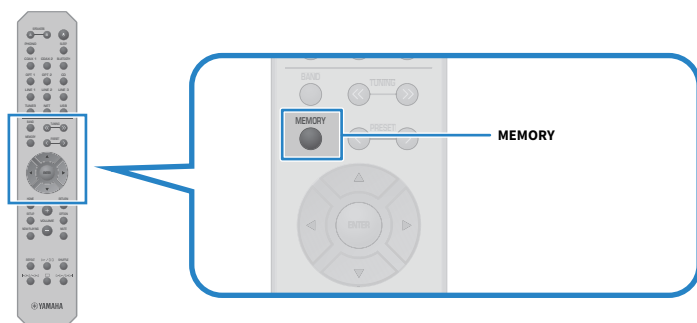

The preset number and content to register are shown on the front display. “Empty” is shown if not registered.

- 3 Select the preset number to register with the PRESET key.**
- 4 Press the MEMORY key.**

The registered preset numbers and “MEMORIZED” or “Memorized” are shown. This completes the registration.

NOTE

- By pressing the MEMORY key for 3 seconds or longer, you can register empty preset numbers automatically. When the input is on "TUNER", however, the radio station will be registered to the next empty number from the previously preset number.
- To go back to the original display without registering, press the RETURN key.
- When network input or USB input is selected, up to 40 different songs or stations that are being played can be registered.
- The type of content that can be registered may vary for streaming services and "Net Radio" according to the selected radio station or the service.

Recalling content registered to a preset

Select the content you want to listen to from the content registered to presets (such as music on media servers or USB devices, or Internet radio stations).

■ Recalling a preset

1 Press the TUNER key, NET key, or USB key.

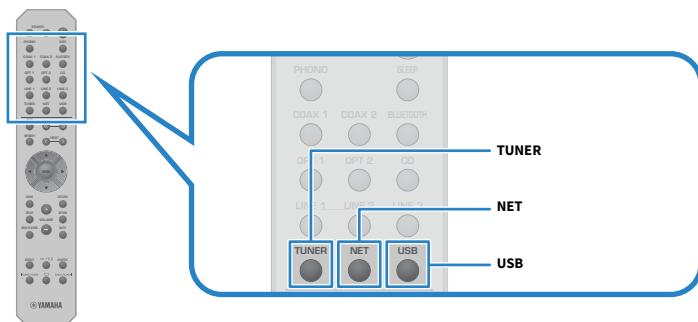

2 Press the PRESET key to select the content you want to listen to.

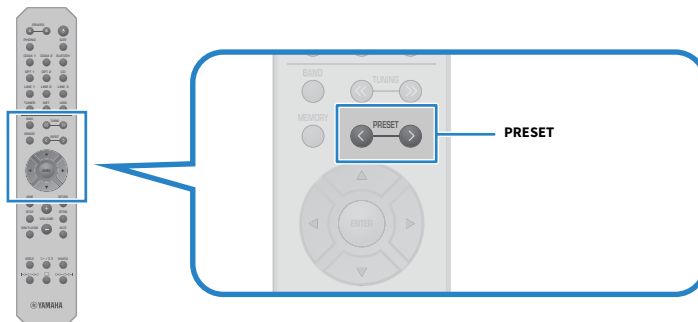

3 Press the ENTER key.

The selected content starts playing.

NOTE

- If no presets at all have been registered, “No Presets” is displayed on the front display.
- You can use MusicCast Controller to view a list of or delete registered content (song name or radio station name).
- “TUNER” presets can only be recalled when the input is on “TUNER”. Some presets, such as “USB”, “Server”, “Net Radio” and/or streaming services, can only be recalled if the input is on “USB” or “NET” (which can be selected by the NET key).
- Presets can only be recalled when the power is turned ON.

Sleep timer function

Configuring the time for the sleep timer

Once the specified time elapses, the product goes into Standby.

1 Press the SLEEP key repeatedly to set the desired time for the sleep timer.

You can choose OFF, 120, 90, 60 or 30 minutes.

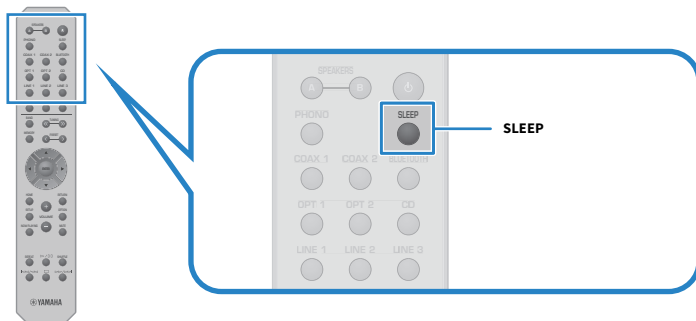

The SLEEP indicator on the front display flashes while a sleep timer setting is being made. Once a setting is made, the SLEEP indicator lights up.

NOTE

- To cancel the sleep timer, select OFF.
- If you put this product into Standby, it cancels the sleep timer setting.

SETTINGS

Menu

Menu structure

This product has the following menus, depending on the use.

Setup menu:

For detailed configuration of the functions of the product. Make settings with the remote control while looking at the front display.

Advanced Setup menu:

For configuring the product's system settings, etc. Can only be operated from the front panel.

NOTE

Play-related settings and information can be managed from the Option menu.

Related links

- “List of Option menu” (p.67)
- “List of Setup menu items” (p.80)
- “List of Advanced Setup menu items” (p.91)

Setup menu (changing function settings)

Basic operation of the Setup menu

For detailed configuration of the functions of the product. The basic operating methods of the Setup menu are as follows.

1 Press the SETUP key.



2 Use the cursor keys (▲/▼) to select an item and press the ENTER key.

To go back a level of the menu, press the RETURN key.

3 Select the desired setting value with the cursor keys.

4 Press the SETUP key.

This completes the configuration.

Related links

- “Menu structure” (p.78)
- “List of Setup menu items” (p.80)

List of Setup menu items

Items in the Setup menu are as follows.

Item	Page	
Network	Connection	81
	Information	
	IP Address	
	DMC Control	
	Network Stdby (Network Standby)	
	Network Name	
	Network Update	
Bluetooth	MC Pwr Intlock (MusicCast Power Interlock)	86
	Bluetooth	
Volume	Standby (Bluetooth Standby)	87
	Max Volume	
AutoPowerStdby (Auto Power Standby)	Initial Volume	88
ECO Mode		89

Configuring a network

■ Setting the method of connecting (wired/wireless) to a network

This sets the method of connecting this product to a network.

Setup menu

“Network” > “Connection”

Setting value

Wired	Connects via a network cable.
Wireless	Connects via Wi-Fi.

Related links

- “To make a network connection” (p.31)
- “Selecting the wireless method of connecting to the network” (p.117)
- “Basic operation of the Setup menu” (p.79)

■ Checking network information

Displays networking information of this product.

Setup menu

“Network” > “Information”

NEW FW	Firmware update available or not
STATUS	State of network jack connections
MC NET	State of MusicCast Network preparations
MAC	MAC address of this product (The MAC address is different depending on whether the connection to the network is wired or wireless)
SSID	Access point this product is connected to (only displayed for Wi-Fi connections)
IP	IP address of this product
SUBNET	Subnet mask
GATEWAY	IP address of the default gateway
DNS P	IP address of primary DNS server
DNS S	IP address of secondary DNS server

Related links

“Basic operation of the Setup menu” (p.79)

■ Auto-configuration of network information (DHCP function)

This function automatically configures the network information (IP address, subnet mask, default gateway, etc.) of this product using a DHCP server.

SETTINGS > Setup menu (changing function settings)

Setup menu

“Network” > “IP Address” > “DHCP”

Setting value

Off	DHCP server not used. Configures the network information manually.
On	DHCP server used. Configures the network information automatically.

Default value

On

Related links

“Basic operation of the Setup menu” (p.79)

■ Configuring network information manually

This explains how to configure the network information (IP address, subnet mask, default gateway, etc.) of this product manually.

Setup menu

“Network” > “IP Address”

- 1 Select “Off” for “DHCP”.**
- 2 Select “Manual Setting” and press the ENTER key.**
- 3 Select item you want to set with the cursor keys (▲/▼).**
- 4 Use the cursor keys (◀/▶) to move the cursor position and the cursor keys (▲/▼) to set the network information.**
- 5 Press the ENTER key.**
- 6 To set a different item, repeat steps 2 to 4.**
- 7 Press the SETUP key.**

This completes the configuration.

Related links

“Basic operation of the Setup menu” (p.79)

SETTINGS > Setup menu (changing function settings)

■ Configuring operations from a digital media controller

This configures whether this product can be controlled from a digital media controller (DMC). When enabled, playback of this product can be controlled from a DMC on the same network as the product.

Setup menu

“Network” > “DMC Control”

Setting value

Disable	Disables control from a DMC.
Enable	Enables control from a DMC.

Default value

Enable

Related links

“Basic operation of the Setup menu” (p.79)

■ Configuring network standby

This sets whether the power of this product can be turned ON from a network device.

Setup menu

“Network” > “Network Stdby (Network Standby)”

Setting value

Off	Disables network standby.
On	Enables network standby. This consumes more energy than when it is “Off”.
Auto	Enables network standby. When in network standby, if “Standby (Bluetooth Standby)” in “Bluetooth” is set to “Off” and the network is disconnected for a certain period of time, the product goes into power save mode to save energy.

Default value

Auto

NOTE

- When “Network Stdby (Network Standby)” is set to “Off”, “Standby (Bluetooth Standby)” in “Bluetooth” is disabled.
- When in the power save mode, this product cannot be turned ON from a network device, even if it is connected via a network cable. Turn the power of this product ON manually.

SETTINGS > Setup menu (changing function settings)

Related links

- “Configuring Bluetooth” (p.86)
- “Basic operation of the Setup menu” (p.79)

■ Setting the network name of this product

You can change the network name of this product that is displayed on the network.

Setup menu

“Network” > “Network Name”

1 Press the ENTER key.

2 Use the cursor keys (◀/▶) to move the cursor position and the cursor keys (▲/▼) to edit the name.

Press the PRESET (>) key to insert characters and the PRESET (<) key to delete them.

3 Press the ENTER key.

4 Press the SETUP key.

This completes the configuration.

Related links

“Basic operation of the Setup menu” (p.79)

■ Updating the firmware

Firmware is updated to add functionality to this product and/or resolve problems.

You can download the latest firmware from the Yamaha website. For details, check the information provided with the firmware when you update it.

Setup menu

“Network” > “Network Update”

Options

Perform Update	Update firmware via the network. This item is only displayed when new firmware is available.
Version	Displays the version of the firmware.
ID	Displays the unique System ID of this product.

NOTE

- When there is an update notification for the latest firmware, press the ENTER key to update the firmware.
- Do not execute this other than when updating the firmware. Before executing an update, check the information provided with the firmware.

SETTINGS > Setup menu (changing function settings)

Related links

- “Updating the firmware” (p.97)
- “Basic operation of the Setup menu” (p.79)

■ Configuring power interlock with MusicCast-compatible devices and this product

This function allows you to set whether MusicCast-compatible devices (slave) turn ON in tandem with this product (master) when it is turned ON.

Setup menu

“Network” > “MC Pwr Intlock (MusicCast Power Interlock)”

Setting value

Off	Does not link the power of this product and that of MusicCast-compatible devices.
On	Links the power of this product and that of MusicCast-compatible devices.

Default value

Off

Related links

“Basic operation of the Setup menu” (p.79)

Configuring Bluetooth

■ Configuring to use Bluetooth

This sets whether or not to use the Bluetooth function.

Setup menu

“Bluetooth” > “Bluetooth”

Setting value

Off	Disables Bluetooth functions.
On	Enables Bluetooth functions.

Default value

On

Related links

- “Playing via a Bluetooth® connection” (p.56)
- “Basic operation of the Setup menu” (p.79)

■ Configuring Bluetooth Standby

This sets whether the power of this product can be turned ON from a Bluetooth device. When set to “On”, this product is turned ON automatically when a connection is made with a Bluetooth device.

Setup menu

“Bluetooth” > “Standby (Bluetooth Standby)”

Setting value

Off	Disables the Bluetooth Standby function.
On	Enables the Bluetooth Standby function. This consumes more energy than when set to “Off”.

Default value

On

NOTE

This setting is not available when “Network Stdby (Network Standby)” in the Setup menu is set to “Off”.

Related links

- “Configuring a network” (p.81)
- “Basic operation of the Setup menu” (p.79)

Configuring the volume

■ Setting the maximum volume

This sets the maximum volume that can be set via the VOLUME keys of the remote control, etc.

Setup menu

“Volume” > “Max Volume”

Setting value

-50.0 dB to 0.0 dB (5.0 dB intervals)

Default value

0.0 dB

Related links

“Basic operation of the Setup menu” (p.79)

■ Setting the power-ON volume

This sets the volume for when the power is turned ON.

Setup menu

“Volume” > “Initial Volume”

Setting value

Off	Uses the volume from the last time the power went into Standby.
Mute	Mutes the volume.
-96.5 dB to 0.0 dB (0.5 dB intervals)	Uses the specified volume. Enabled only when the volume is set lower than “Max Volume”.

Default value

Off

Related links

“Basic operation of the Setup menu” (p.79)

Configuring auto power standby

This setting is for making the power of this product go into Standby automatically.

Setup menu

“AutoPowerStdby (Auto Power Standby)”

Setting value

Off	Does not go into Standby automatically.
On	Goes into Standby when any of the following conditions is met. <ul style="list-style-type: none">• When the product has not been operated for 8 hours• When the input is “NET” (which can be selected by the NET key), “Bluetooth” or “USB” and it has not been played for 20 minutes

Default value

On

Related links

“Basic operation of the Setup menu” (p.79)

Setting the product to ECO mode

Sets the product to the ECO mode (power-saving function).

When the setting has been changed, press the ENTER key to restart the product. The new setting is applied after restarting.

Setup menu

“ECO Mode”

Setting value

Off	Disables the ECO mode.
On	Enables the ECO mode. The front display may become dark.

Default value

Off

Related links

“Basic operation of the Setup menu” (p.79)

Advanced Setup menu (changing system settings)

Basic operation of the Advanced Setup menu

For changing system settings for the product. Operate as follows from the front panel.

1 If the power of the product is ON, press the ⏻ (Power) Switch to turn it OFF.

2 Press the ⏻ (Power) Switch while holding down RETURN.

The Advanced Setup menu opens on the front display.



3 Turn SELECT to select a setting item.

4 Press SELECT to choose a setting value.

5 Press the ⏻ (Power) Switch to turn OFF the power.

6 Press the ⏻ (Power) Switch again to turn the power back ON.

The changes to settings are reflected.

Related links

- “Menu structure” (p.78)
- “List of Advanced Setup menu items” (p.91)

List of Advanced Setup menu items

Items in the Advanced Setup menu are as follows.

Item	Page
SP IMP. (Speaker Impedance)	92
REMOTE ID	93
TU (Frequency Step)	94
INIT (Initialization)	95
UPDATE (Firmware Update)	99

NOTE

Only the items that can be configured are shown on the front display.

Switching speaker impedance

Changes this product setting to match the impedance of the connected speakers.

Advanced Setup menu

“SP IMP. (Speaker Impedance)”

Setting value

4ΩMIN	For speakers with an impedance of 4-ohm or more but less than 8-ohm.
8ΩMIN	For speakers with an impedance of 8-ohm.

Default value

8ΩMIN

Related links

“Basic operation of the Advanced Setup menu” (p.90)

Configuring the Remote ID

This changes the Remote ID of the main unit of this product. Normally you should set it to “ID1”.

Advanced Setup menu

“REMOTE ID”

Options

ID1	Sets the Remote ID to ID1.
AUTO	Assigns the Remote ID automatically. Use this setting when operating the product using the remote control that is included with some Yamaha CD/network players.

Default value

ID1

Related links

“Basic operation of the Advanced Setup menu” (p.90)

Changing the FM/AM tuning frequency setting

Model For

Asia, Taiwan, Central and South America

Sets the FM/AM tuning frequency setting of this product depending on your country or region.

Advanced Setup menu

“TU (Frequency Step)”

Setting value

FM100/AM10	Adjusts the FM frequency by 100-kHz steps and AM by 10-kHz steps.
FM50/AM9	Adjusts the FM frequency by 50-kHz steps and AM by 9-kHz steps.

NOTE

Preset (registered radio stations) and frequency will be initialized if you change the radio tuning frequency steps.

Related links

- “Preparing to listen to the radio” (p.46)
- “Basic operation of the Advanced Setup menu” (p.90)

SETTINGS > Advanced Setup menu (changing system settings)

Initializing settings

Initializes (resets) the various settings of the product.

Advanced Setup menu

“INIT (Initialization)”

Options

ALL	Initializes all settings.
NETWORK	Initializes network-related settings.
CANCEL	Cancels initialization.

Default value

CANCEL

Related links

“Basic operation of the Advanced Setup menu” (p.90)

UPDATING

Checking the version of firmware

Checking the version of firmware

The version of this product's firmware can be checked from the Setup menu. Do so as follows.

- 1 Press the SETUP key.**
- 2 Select "Network" with the cursor keys (▲/▼) and then press the ENTER key.**
- 3 Then select "Network Update" and press the ENTER key.**
- 4 Confirm the version of firmware in "Version".**

The version of firmware appears on the front display.

To close the Setup menu, press the SETUP key.

NOTE

The version of firmware can also be checked from the MusicCast Controller menu.

Related links

- "Configuring a network" (p.81)
- "Updating the firmware" (p.97)

Updating the firmware

Updating the firmware

Updated firmware is provided to add functionality to this product and/or resolve problems. For details about firmware, please visit the Yamaha website. The firmware can be updated either via the Internet or by using USB flash drive.

Related links

- “Updating the firmware via your network” (p.98)
- “Updating firmware via USB flash drive” (p.99)

Updating the firmware via your network

If this product is connected to the Internet and it is ready for a new firmware update, the following message appears when you turn this product ON.



Update the firmware as follows over the network from this message. If you want to update later, press the RETURN key to cancel updating.

NOTICE

- Do not operate the product or unplug its power cord or network cable during the updating process. If the process is interrupted, this product may become unusable. If that happens, please contact an authorized Yamaha service center to have it repaired.

1 Press the ENTER key.

“Perform Update” is displayed on the front display.

2 Press the ENTER key.

Updating of the firmware starts.

3 Once “Update Success” is shown on the front display, press the (power) switch on the unit.

This completes the firmware update.

NOTE

- It takes about 10 minutes to update the firmware.
- Updating firmware may fail if there is a problem with the network connection. If this happens, wait a while and try again, or use USB flash drive for updating.
- You can check whether there are any new firmware updates by selecting the following menu items in order: Setup menu > “Network” > “Information” > “NEW FW”.
- When new firmware is available, you can perform the update via Setup menu > “Network” > “Network Update”.

Related links

- “Configuring a network” (p.81)
- “Updating the firmware” (p.97)

Updating firmware via USB flash drive

You can download the latest firmware from the Yamaha website, and the firmware can be updated by using a USB flash drive. For the information about the firmware, please visit the product information pages of the Yamaha website.

NOTICE

- Do not operate the product, unplug the power cord, or remove the USB flash drive while updating the firmware. If the process is interrupted, this product may become unusable. If that happens, please contact an authorized Yamaha service center to have it repaired.

About the USB flash drive used

Use the USB flash drive that meets the following conditions.

- Compatible with USB Mass Storage Class
- Formatted in FAT16 or FAT32
- No encryption functionality
- The absence of any data (Empty)

■ Firmware update procedure

Update the firmware as follows. Operate as follows from the front panel.

1 Download the firmware.

For the information about the firmware, please visit the product information pages of the Yamaha website.

2 Extract (uncompress) the downloaded compressed files.

3 Save the firmware (binary file format) on the USB flash drive.

Save it at the head of the top-level folder (root folder) on the USB flash drive. When saving, do not change the file name.

4 Plug the USB flash drive into the USB port of this product.

5 If the power of the product is ON, press the (Power) Switch to turn it OFF.

6 Press the (Power) Switch while holding down RETURN.

The Advanced Setup menu is shown on the front display.

7 Turn SELECT to select “UPDATE.....USB”.

8 Press DISPLAY.

Updating of the firmware starts. Once the update is made, “UPDATE SUCCESS”, “PLEASE...”, and “POWER OFF” is shown in sequence. (This message will disappear after about 10 seconds.)

9 Press the  (Power) Switch to turn it OFF, and then, remove the USB flash drive from the USB port of this product.

This completes the firmware update.

NOTE

The version of this product's firmware can be checked from the Setup menu.

■ If the product does not start up normally after the firmware update

Update the firmware again as follows.

- 1 Unplug the power cord of this product from an outlet, and press the  (Power) Switch to turn it ON.**
- 2 Plug the USB flash drive in which you saved the firmware into the USB port of this product.**
- 3 Plug the power cord into an outlet while holding down DIMMER.**
- 4 After “USB UPDATE” is shown on the front display, stop holding down DIMMER.**

Updating of the firmware starts. Once the update is made, “UPDATE SUCCESS”, “PLEASE...”, and “POWER OFF” is shown in sequence. (This message will disappear after about 10 seconds.)

- 5 Press the  (Power) Switch to turn it OFF, and then, remove the USB flash drive from the USB port of this product.**

Related links

- “Updating the firmware” (p.97)
- “Checking the version of firmware” (p.96)
- “Errors shown on the front display” (p.114)

TROUBLESHOOTING

If you think there is a problem

If you think there is a problem, the 1st step is checking the following

If the product stops working normally while you are using it, check the following items first.

- The power plugs of the product and audio device(s) (CD player, etc.) are firmly plugged into their outlets.
- The power of the product, the subwoofer and audio devices (CD player, etc.) is turned on.
- The cables between devices are securely plugged into the jacks.

Problems with power, system, and/or remote control

Power fails to turn ON

● **The protective circuit has been activated 3 times in a row.**

If the Power Indicator on the front panel flashes when you try to turn the power ON, it fails to come on in order to protect the product. Please contact an authorized Yamaha service center to have it repaired.

Power fails to turn OFF

● **The built-in microcomputer has frozen due to an external electrical shock (such as from lightning or excessive static electricity) or a drop in electrical voltage.**

Turn OFF the power using the ⏻ (Power) Switch on the front panel, wait at least 15 seconds, then turn the power ON.

Power turns OFF right away

● **You may be trying to turn ON the power while the speaker cables are shorted.**

Firmly twist the core wires of each of the speaker cables and then reconnect them to this product and the speakers. For more details, refer to the following.

- “Connecting speakers” (p.23)

Power switches to standby automatically

● **The sleep timer activated.**

Turn the power back ON and start playback. For more details, refer to the following.

- “Configuring the time for the sleep timer” (p.77)

● **The Auto Power Standby function was activated as the set period of time elapsed without operating the product.**

To disable the Auto Power Standby function, set “AutoPowerStdby (Auto Power Standby)” to “Off” from the Setup menu. For more details, refer to the following.

- “Configuring auto power standby” (p.88)

● **Due to a short in the speaker cables, the protective circuit was activated.**

Firmly twist the core wires of each of the speaker cables and then reconnect them to this product and the speakers. For more details, refer to the following.

- “Connecting speakers” (p.23)

● **The volume was increased too high, activating the protective circuit.**

Lower the volume.

The product does not respond to controls

● **The built-in microcomputer has frozen due to an external electrical shock (such as from lightning or excessive static electricity) or a drop in electrical voltage.**

Turn OFF the power using the ⏻ (Power) Switch on the front panel, wait at least 15 seconds, then turn the power ON.

This product cannot be operated with the remote control

● **The ⏻ (Power) Switch on the front panel is OFF.**

Turn the ⏻ (Power) Switch on the front panel ON.

● **It is outside the operating range.**

Try using it within the operating range. For more details, refer to the following.

- “How to insert batteries, and its operating range” (p.21)

● **Its batteries are dead.**

Replace with new batteries.

● **Strong light or sunlight is hitting the remote control signal receiver on the main unit.**

Change the lighting or the orientation of the unit.

The front display is OFF

● **Pure Direct is ON.**

When using Pure Direct, the front display turns OFF. After turning OFF, the display comes back ON when the remote control or front panel is operated.

Problems with the audio

No sound

● **A different input is selected.**

Use the input source selection key to select the correct input. For more details, refer to the following.

- “Selecting an input source” (p.39)

● **The product is receiving an input signal that it cannot play.**

This product cannot play some digital audio formats. Make sure the signal is in a format that this product can play. See the following for information on supported file formats and decoding formats.

- “Supported file formats on this product (network/USB)” (p.123)
- “Specifications” (p.125)

● **A cable connecting this product and an audio device is damaged.**

If you check the connections and they seem fine, replace the cable with a different one.

● **The output speakers are not set correctly.**

Press the SPEAKERS A or SPEAKERS B key corresponding to the jacks to which the speakers are connected to turn their output ON. For more details, refer to the following.

- “Selecting the output speakers” (p.38)

● **The audio is muted.**

Press the MUTE key to cancel muting.

● **Headphones are plugged into the PHONES jack.**

Unplug the headphones.

● **This product was put into Standby by the Auto Power Standby function.**

Set “AutoPowerStdby (Auto Power Standby)” to “Off” from the Setup menu. For more details, refer to the following.

- “Configuring auto power standby” (p.88)

Volume cannot be increased

● **The maximum volume is set too low.**

Adjust the maximum value via “Max Volume” in “Volume” in the Setup menu. For more details, refer to the following.

- “Configuring the volume” (p.87)

● **The power of the external device connected to the output jacks of this product is OFF.**

Turn all corresponding devices ON.

● **The volume interlocks between each device and this product have not been configured for Bluetooth/AirPlay playback from a Bluetooth device or AirPlay device.**

Configure the volume interlocks of each device via “Vol. Interlock (Volume Interlock)” on the Option menu. For more details, refer to the following.

- “Setting volume interlock with this product when playing an AirPlay/Bluetooth device” (p.72)

● **LOUDNESS is set too low.**

First, lower the volume with VOLUME, then return LOUDNESS to the FLAT position and readjust the volume.

TROUBLESHOOTING > If you think there is a problem

No sound is output from a particular speaker

- **BALANCE is set to the maximum for either left or right.**

Adjust BALANCE so sound comes out of the left and right speakers.

- **A cable connecting this product and the corresponding speaker is damaged.**

Check the connections of each jack on the speaker(s) and this product, and if no problem exists with the connections, the cable may be broken. Replace the cable with a different one.

- **The corresponding speaker may be damaged.**

You can check this by replacing it with a different speaker that is functioning normally. If sound does not come from the replacement speaker either, this product may be faulty.

No sound is output from the subwoofer

- **The volume of the subwoofer is extremely low.**

Adjust the volume on the subwoofer itself.

- **The auto standby function of the subwoofer (automatically turning the power OFF) was activated.**

Disable auto-standby or adjust its operating sensitivity on the subwoofer itself.

Noise is being output

- **Digital and/or high frequency equipment is located near this product.**

Increase the distance between this product and such devices.

- **A cable connecting this product and an audio device is damaged.**

If you check the connections and they seem fine, replace the cable with a different one.

Sound is distorted

- **The volume is too loud.**

Lower the volume.

Problems with FM radio

Radio reception is poor or has noise

● **It is receiving multipath (multiple reflections) or other interference.**

Change the height, orientation, and/or location of the FM antenna.

● **The radio station is being received from a distant region.**

Press MODE on the front panel and switch to Mono reception. For more details, refer to the following.

- “Selecting a radio station” (p.49)

Automatic selection of FM radio stations is not possible

● **The FM radio stations are being received from distant regions.**

Manually select stations. For more details, refer to the following.

- “Selecting a radio station” (p.49)

Alternatively, use an outdoor antenna (commercially-available).

Cannot select radio stations by pressing the PRESET key

● **No radio stations are registered.**

If no radio stations at all have been registered, “No Presets” is displayed on the front display when the PRESET key is pressed. Register radio stations to preset numbers. For more details, refer to the following.

- “Registering radio stations manually” (p.53)

Auto presets can also be used for FM radio stations. For more details, refer to the following.

- “Auto-registering FM radio stations (auto preset)” (p.52)

If the signals of FM radio stations are weak, no stations at all may be registered when auto preset is performed. In that case, register them manually.

● **The input is on something other than “TUNER”.**

Press the TUNER key. “TUNER” presets can only be recalled when the input is on “TUNER”.

Problems with AM radio

AM radio reception is poor or has noise

● **It is picking up noise from sources like fluorescent lights, motors, etc.**

It is difficult to completely eliminate noise from the environment. However, using a commercially-available outdoor antenna may help reduce the noise.

Automatic selection of AM radio stations is not possible

● **The AM radio signal is weak.**

Change the direction of the AM antenna.

Manually select stations. For more details, refer to the following.

- “Selecting a radio station” (p.49)

Cannot register (preset) any AM radio stations

● **The auto registration function (auto preset) is being used.**

Auto preset only works with FM radio stations. Please register AM radio stations manually. For more details, refer to the following.

- “Registering radio stations manually” (p.53)

Cannot select radio stations by pressing the PRESET key

● **No radio stations are registered.**

If no radio stations at all have been registered, “No Presets” is displayed on the front display when the PRESET key is pressed. Register radio stations to preset numbers. For more details, refer to the following.

- “Registering radio stations manually” (p.53)

● **The input is on something other than “TUNER”.**

Press the TUNER key. “TUNER” presets can only be recalled when the input is on “TUNER”.

Problems with DAB radio

No DAB radio reception

● **An initial scan has not been performed.**

Perform an initial scan to receive DAB radio. For details, see the following:

- “Preparing the DAB tuning” (p.47)

No DAB radio reception even after performing an initial scan

● **Reception strength of DAB radio is poor.**

Check reception strength via “Tune AID” on the Option menu, and adjust the antenna height or orientation, or place it in a different location. For details, see the following:

- “Preparing the DAB tuning” (p.47)

● **There is no DAB coverage in your area.**

Check with your dealer or WorldDMB online at “<http://www.worlddab.org>” for a listing of the DAB coverage in your area.

DAB radio reception is poor or has noise

● **There is multi-path interference.**

Check reception strength via “Tune AID” on the Option menu, and adjust the antenna height or orientation, or place it in a different location. For details, see the following:

- “Preparing the DAB tuning” (p.47)

● **Your area is too far from the DAB station transmitter.**

Use an outdoor antenna. We recommend using a sensitive multi-element antenna.

DAB information is not available or is inaccurate

● **The selected DAB radio station may be temporarily out of service or may not provide information.**

Contact the DAB broadcaster.

No DAB radio sound

● **The selected DAB radio station may be temporarily out of service.**

Try the station later or select another station.

Problems with USB

The USB device is not recognized

- **The USB device is not plugged into the USB port correctly.**
Turn OFF this product and then plug the USB device in again.
- **The USB device being used is in a format other than FAT16/32.**
Use a FAT16/32 formatted USB device.

The folders and/or files are not displayed

- **The data on the USB device is protected via an encryption function.**
Use a USB device that is not encrypted.

The content on the USB device fails to play when its preset number is selected

- **A USB device other than the one at the time of registration is plugged in.**
Connect the USB device registered to the preset number.
- **The registered content (files) was moved to a different folder.**
Register the content again.
- **Other music files were added to or deleted from the folder.**
It may not be possible to recall registered content. Register the content again.

Files on the USB device fail to play consecutively

- **The selected folder contains files that cannot be played on the product.**
Do not put files that cannot be played on the product into the folder to be played. Refer to the following for the music file formats supported by this product.
 - “Supported file formats on this product (network/USB)” (p.123)
- **The selected folder contains 500 or more songs.**
Up to 500 songs can be played. The maximum number of songs may be lower, depending on the folder structure.

Problems with network

Network functions cannot be used

● **Network information (IP address) was not acquired properly.**

Enable the DHCP server function of the router. Set “DHCP” to “On” from the Setup menu of this product. For more details, refer to the following.

- “Configuring a network” (p.81)

If you configure the network information manually instead of using the DHCP server, make sure the IP address of this product is not the same as any other network devices.

● **It is connected to an IPv6 type of router.**

Some network functions of this product are not supported in IPv6 networks. Connect to an IPv4 network.

Cannot connect to the Internet via a wireless LAN router (access point)

● **The power of the wireless LAN router is OFF.**

Turn the wireless LAN router ON.

● **This product is too far from the wireless LAN router.**

Move the wireless LAN router and/or this product closer to each other.

● **There is an obstacle between this product and the wireless LAN router.**

Remove the obstacle between this product and the wireless LAN router.

● **The wireless LAN router (access point) is configured to use Channel 14.**

Change the wireless LAN router (access point) settings so it uses one of the channels between 1 and 13.

● **The MAC address filter of the wireless LAN router (access point) is enabled.**

Set the MAC address filter of the wireless LAN router (access point) to disabled.

Cannot find the wireless network

● **Electromagnetic waves from a microwave oven or other wireless devices are interfering with wireless communication.**

Turn those devices OFF, or move them away from this product and the wireless LAN router. Also, if your wireless LAN router supports the 5 GHz frequency band, switch the connection to the 5 GHz band.

● **Access to the network is restricted by the firewall settings of the wireless LAN router.**

Check the firewall settings of your wireless LAN router.

Cannot detect a media server (PC/NAS)

● **The share settings of the media server are not correct.**

Change the share settings of the media server so this product can access the folders on the media server.

● **Access to the media server is restricted by security software settings, etc.**

Check the security software settings of the media server and/or router.

● **This product is not connected to the same network as the media server.**

Check the network connections and/or the router settings, and connect this product with the media server over the same network (router).

Media server (PC/NAS) files will not display (or play)

● **This product or the media server are using unsupported file format(s).**

Use file formats that are supported by both this product and the media server. Refer to the following for the music file formats supported by this product.

- “Supported file formats on this product (network/USB)” (p.123)

Media server (PC/NAS) content cannot be played when its preset number is selected

● **The power of the media server (PC/NAS) is OFF.**

Make sure the power of the media server (PC/NAS) is ON.

● **Not connected to the network.**

Check the network connections and/or the router settings.

● **The registered content (files) was moved to a different folder.**

Register the content again.

● **Other music files were added to or deleted from the folder.**

It may not be possible to recall registered content. Register the content again.

Cannot play Internet radio

● **Not connected to the Internet.**

In order to use Internet radio, this product must be connected to the Internet. Check and make sure the network information (IP address) was acquired properly. For more details, refer to the following.

- “Configuring a network” (p.81)

● **The selected Internet radio station service is not currently available.**

It may not be possible to receive the radio station due to a network error on the radio station side, or the service may currently be stopped. Wait for a while and try playing it again, or select a different radio station.

● **The selected Internet radio station is broadcasting silence.**

Some radio stations broadcast silence at some times. In such a case, no sound plays even if the station is being received. Wait for a while and try playing it again, or select a different radio station.

● **Access to the network is restricted by the firewall settings of the router or network devices.**

Check the firewall settings. Note that Internet radio can only be played via the port specified by each radio station. The port number differs depending on the radio station.

When using AirPlay, this product is not detected by the iPhone

● **You are using a router that supports multi SSID.**

The network isolating function of your wireless LAN router (access point) may be preventing access to this product. When connecting your iPhone, use an SSID that allows access to this product (try connecting to the primary SSID).

Music doesn't play via AirPlay

● **You are trying to listen to music that cannot be played on your iPhone.**

Make sure the files are playable. If you cannot play it even on your iPhone itself, the music data and/or storage area may be damaged.

This product is not detected by the dedicated app on the mobile device

- **This product is not connected to the same network as the mobile device.**

Check the network settings and/or the router settings and connect to the same network.

- **You are using a router that supports multi SSID.**

The network isolating function of your wireless LAN router (access point) may be preventing access to this product. When connecting your mobile device, use an SSID that allows access to this product (try connecting to the primary SSID).

Unable to update the firmware via the network

- **Your network connection is poor.**

Wait a while and try again. Otherwise, use USB flash drive for updating.

Problems with Bluetooth

Cannot connect with a Bluetooth device

● **The wireless antenna of this product is not up.**

Stand the wireless antenna upright.

● **The Bluetooth function of this product is disabled.**

Enable the Bluetooth function with “Bluetooth” on the Setup menu. For more details, refer to the following.

- “Configuring Bluetooth” (p.86)

● **The Bluetooth function of the Bluetooth device is OFF.**

Turn ON the Bluetooth function of the Bluetooth device.

● **This product is connected to a different Bluetooth device.**

Terminate the current Bluetooth connection and connect to the desired Bluetooth device. For more details, refer to the following.

- “Playing via a Bluetooth® connection” (p.56)

● **This product and the Bluetooth device are too far apart.**

Move this product and the Bluetooth device closer together.

● **Interference from device(s) (microwave oven, wireless LAN, etc.) using the 2.4 GHz frequency band is impeding wireless communications.**

Move this product and/or the Bluetooth device away from those devices. Also, if your wireless LAN router supports the 5 GHz frequency band, switch the connection to the 5 GHz band.

● **The Bluetooth device you are using does not support the A2DP and/or AVRCP profiles.**

Use a Bluetooth device that supports the A2DP and/or AVRCP profiles.

● **The connection information registered to the Bluetooth device is not functioning properly for some reason.**

Delete the connection information of the Bluetooth device and then reconnect this product to the Bluetooth device. For more details, refer to the following.

- “Playing via a Bluetooth® connection” (p.56)

When connected via Bluetooth®, there is no sound, or the sound is intermittently disrupted

● **The volume of the Bluetooth device is too low.**

Turn up the volume of the Bluetooth device.

● **The output-switching of the Bluetooth device is not set to this product.**

Set the output-switching of the Bluetooth device to this product.

● **The Bluetooth connection was cut off.**

Reconnect the Bluetooth. For more details, refer to the following.

- “Playing via a Bluetooth® connection” (p.56)

● **They are too far apart.**

Move the Bluetooth device closer to this product.

Errors shown on the front display

When an error is shown on the front display, check it in the following table.

Message	Contents	Solution
Check SP Wires	The speaker cable(s) are shorted.	Firmly twist the core wires of each of the speaker cables and then reconnect them to this product and the speakers. For more details, refer to the following. <ul style="list-style-type: none"> • “Connecting speakers” (p.23)
Access denied	The media server (PC/NAS) is denying access.	Change the share settings of the media server (PC/NAS) so this product can access the folders on the media server.
Access error	Cannot access the USB device.	Turn OFF this product and then plug the USB device in again. If the message is still displayed, move the music files to a different USB device and play them.
	There is a problem with the network.	Check whether the router and/or modem are ON and whether this product is connected properly with the router (or hub). For more details, refer to the following. <ul style="list-style-type: none"> • “Connecting a network cable (wired connection)” (p.32) • “Preparing the wireless antenna (wireless connection)” (p.33)
No content	No files that the product can play are in the selected folder.	Select a folder that contains files that the product can play.
Please wait	The product is making necessary preparations for connecting to a network.	Wait until the message disappears. If it fails to disappear after 3 minutes, turn the power OFF and then back ON.
Unable to play	Music files on the USB device fail to play.	Make sure the files are playable on this product. Refer to the following for the music file formats supported by this product. <ul style="list-style-type: none"> • “Supported USB devices” (p.122) • “Supported file formats on this product (network/USB)” (p.123) If the music data cannot be played on any other device, it may be corrupted.
	Music files on a media server (PC/NAS) fail to play.	Make sure the files are playable on this product. Refer to the following for the music file formats supported by this product. <ul style="list-style-type: none"> • “Supported file formats on this product (network/USB)” (p.123) If the file(s) are supported by this product but still cannot be played, the network may be overloaded.
USB Overloaded	Too much current flowing to the USB device.	Turn OFF this product and then plug the USB device in again. If the message is still displayed, move the music files to a different USB device and play them.
Not Found	No firmware file is stored in the USB flash drive while updating the firmware.	Verify that the latest firmware is stored in your USB flash drive. For more details, refer to the following. <ul style="list-style-type: none"> • “Updating firmware via USB flash drive” (p.99)
Version error	Error in updating the firmware.	Try updating the firmware again. For more details, refer to the following. <ul style="list-style-type: none"> • “Configuring a network” (p.81) • “Updating the firmware” (p.97)

TROUBLESHOOTING > If you think there is a problem

Message	Contents	Solution
Update failed.	Error in updating the firmware.	Try updating the firmware again. Update by using the USB flash drive instead of updating via your network. For more details, refer to the following. <ul style="list-style-type: none">• “Updating firmware via USB flash drive” (p.99)

APPENDIX

Product care

Taking care of this product

Check the following before cleaning the product.

- Do not use chemicals such as benzene, thinner, or rubbing alcohol on the product. To avoid scratching the surface, wipe it dry with a soft cloth.

Making wireless network connections

Selecting the wireless method of connecting to the network

Select the connection method suiting your network environment.

- 1 Press the SETUP key.**
- 2 Select “Network” with the cursor keys (▲/▼) and then press the ENTER key.**
- 3 Then select “Connection” and “Wireless” in that order and press the ENTER key.**

Select the method of setting up a wireless connection from the following.

- “Using the WPS button to make a wireless connection” (p.118)
- “Making a wireless connection with your iPhone (WAC)” (p.119)
- “Making a wireless connection manually” (p.120)

NOTE

Network settings can also be made when registering this product to the MusicCast Network. We recommend this method when using MusicCast.

Related links

“Registering with the MusicCast network” (p.37)

Using the WPS button to make a wireless connection

Pressing the WPS button on your wireless LAN router is a simple way to configure a wireless connection.

Setup menu

“Network” > “Connection” > “Wireless”

- 1 Select “WPS” with the cursor keys (▲/▼) and then press the ENTER key.**
- 2 Once “Connect[ENTER]” is shown on the front display, press the ENTER key.**
- 3 Once “Connecting” is shown on the front display, press the WPS button on the wireless LAN router (access point).**

Once the connection is made, “Completed” is shown and the Wireless LAN indicator lights up on the front display.

If “Not connected” is displayed, either repeat the process from step 1 or try a different connection method.

This completes the wireless connection process.

NOTE

This product cannot connect to a wireless LAN router (access point) using the WEP encryption method. In such case, try a different connection method.

What is WPS?

WPS (Wi-Fi Protected Setup) is a standard developed by the Wi-Fi Alliance. WPS make it easy to set up a wireless network.

Related links

“Selecting the wireless method of connecting to the network” (p.117)

Making a wireless connection with your iPhone (WAC)

Apply the network settings of your iPhone (iOS device) to this product to set up a wireless connection.

Before starting setup, check and make sure your iPhone is connected to the wireless LAN router (access point).

Setup menu

“Network” > “Connection” > “Wireless”

- 1 Select “Share Setting” with the cursor keys (▲/▼).**
- 2 Select “Wireless (WAC)” with the cursor keys (▲/▼).**
- 3 Open the Wi-Fi setting screen on your iPhone (iOS device) and set this product as an AirPlay speaker.**
- 4 Select the wireless network (access point) which is shared with this product.**

After the sharing operation is complete, this product will connect automatically to the selected wireless network (access point).

Also, the Wireless LAN indicator lights up on the front display.

This completes the wireless connection process.

NOTE

- The following settings are initialized.
 - Network settings
 - Bluetooth settings
 - Content registered to presets (songs from a media server, Internet radio stations, etc.)
 - Account information of the various music services
 - Repeat/shuffle settings
- This product cannot connect to a wireless LAN router (access point) using the WEP encryption method. In such case, try a different connection method.
- A warning message is displayed if a network cable is connected to this product. Unplug the network cable before operating the product.
- If an AirPlay password has been set up, cancel it temporarily and connect using WAC.

Related links

“Selecting the wireless method of connecting to the network” (p.117)

Making a wireless connection manually

Enter the required information and set up a wireless connection. You will have to configure the SSID (network name), encryption method and security key manually.

Setup menu

“Network” > “Connection” > “Wireless”

1 Select “Manual Setting” with the cursor keys (▲/▼).

2 Enter the necessary information as indicated on the front display.

To enter text, use the cursor keys (◀/▶) to move the cursor, and then the cursor keys (▲/▼) to change the character. Press the PRESET (>) key to insert characters and the PRESET (<) key to delete them.

3 Select “Connect[ENTER]” with the cursor keys (▲/▼) and then press the ENTER key.

“Connect[ENTER]” is only shown when there are no problems with the settings.

Once the connection is made, “Completed” is shown and the Wireless LAN indicator lights up on the front display.

If “Not connected” is displayed, either repeat the process or try a different connection method.

This completes the wireless connection process.

Related links

“Selecting the wireless method of connecting to the network” (p.117)

Supported devices and formats

Supported Bluetooth devices

Check the following for the Bluetooth devices that can connect to this product.

- Bluetooth devices that support A2DP and AVRCP profiles can be connected.
- Connection to all Bluetooth devices is not guaranteed.

Supported USB devices

Check the following to see if your USB device is supported by this product.

- USB flash drive formatted in FAT16 or FAT32 is supported.
Do not plug in any other USB devices.
- USB devices with an encryption function cannot be used.
- There is no guarantee that all USB devices can be connected.

Supported file formats on this product (network/USB)

The following file formats can be played on this product.

File	Sampling frequency (kHz)	No. of quantization bits (bit)	Bit rate (kbps)	No. of channels	Gapless Playback Support
WAV*	32/44.1/48/88.2/96/ 176.4/192/352.8/384	16/24/32	-	2	○
MP3	32/44.1/48	-	8 to 320	2	-
WMA	32/44.1/48	-	8 to 320	2	-
MPEG-4 AAC	32/44.1/48	-	8 to 320	2	-
FLAC	32/44.1/48/88.2/96/ 176.4/192/352.8/384	16/24	-	2	○
ALAC	32/44.1/48/88.2/96	16/24	-	2	○
AIFF	32/44.1/48/88.2/96/ 176.4/192/352.8/384	16/24/32	-	2	○
DSD	2.8 MHz (DSD64)/ 5.6 MHz (DSD128)/ 11.2 MHz (DSD256)	1	-	2	○

* linear PCM format only. Files in 32-bit float cannot be played.

- The file formats that can be played vary with the server software installed on the media server (PC/NAS). For more details, refer to the user's manual of the server software.
- Files protected by DRM (Digital Rights Management) cannot be played.

Trademarks

Trademarks

The trademarks used in this manual are as follows.



This Receiver is compatible with AirPlay 2. iOS 11.4 or later is required.

Use of the Works with Apple badge means that an accessory has been designed to work specifically with the technology identified in the badge and has been certified by the developer to meet Apple performance standards.

Apple, AirPlay, Apple TV, Apple Watch, iPad, iPad Air, iPad Pro, iPhone, Lightning, and iTunes are trademarks of Apple Inc., registered in the U.S. and other countries and regions.

App Store

App Store is a service mark of Apple Inc., registered in the U.S. and other countries.

Android Google Play

Android and Google Play are trademarks of Google LLC.



The Wi-Fi CERTIFIED™ Logo and Wi-Fi Protected Setup Logo are registered trademark of Wi-Fi Alliance®.

Wi-Fi, Wi-Fi CERTIFIED, Wi-Fi Protected Setup and WPA2 are trademarks or registered trademarks of Wi-Fi Alliance®.



The Bluetooth® word mark and logos are registered trademarks owned by Bluetooth SIG, Inc. and any use of such marks by Yamaha Corporation is under license. Other trademarks and trade names are those of their respective owners.



MusicCast is a trademark or registered trademark of Yamaha Corporation.

GPL/LGPL

This product utilizes GPL/LGPL open-source software in some sections. You have the right to obtain, duplicate, modify, and redistribute this open-source code only. For information on GPL/LGPL open source software, how to obtain it, and the GPL/LGPL license, refer to the Yamaha Corporation website

(<https://download.yamaha.com/sourcecodes/musiccast/>).

Licenses

For information on the licenses of the third-party software in this product, refer to the following.

[http://\(IP address of this product*\)/licenses.html](http://(IP address of this product*)/licenses.html)

* IP address of this product is checked with MusicCast Controller.

Specifications

Specifications

The specifications of this unit are as follows.

Input jacks

Analog Audio

- Audio x 5 (including PHONO)

Digital Audio

- Optical x 2 (PCM only) (Supported frequencies: 32 kHz/44.1 kHz/48 kHz/88.2 kHz/96 kHz/176.4 kHz/192 kHz)
- Coaxial x 2 (PCM only) (Supported frequencies: 32 kHz/44.1 kHz/48 kHz/88.2 kHz/96 kHz/176.4 kHz/192 kHz)

Other jacks

- USB x 1 (Type-A)
- NETWORK (Wired) x 1 (100Base-TX/10Base-T)

Output jacks

Analog Audio

- Speaker Out x 4 (A L/R, B L/R)
- Subwoofer Out x 1 (monaural)
- Headphone x 1
- Audio x 2

TUNER

Analog Tuner

- [Models for U.K., Europe and Russia]
DAB/FM with Radio Data System x 1 (TUNER)
- [Model for Australia]
DAB/FM x 1 (TUNER)
- [Models for U.S.A., Canada, China, Korea, Asia, Taiwan and for Central and South America]
FM/AM x 1 (TUNER)

Bluetooth

Sink Function

- Source Device to this product (ex. Smartphone/Tablet)
- Supported profile
 - A2DP v1.3, AVRCP v1
- Supported codec
 - SBC, AAC

Source Function

- This product to Sink Device (ex. Bluetooth Headphone)
- Supported profile
 - A2DP v1.3
- Supported codec
 - SBC
- Capable of Play/Stop Operation from Sink Device

Bluetooth version

- Ver. 4.2

Wireless output

- Bluetooth Class 2

Network

media servers (PC/NAS)

AirPlay 2

Internet Radio

music streaming service

MusicCast

- Controlled by MusicCast Controller App.
- MusicCast Link function*
 - * The following audio distribution is restricted.
 - PCM (352.8 kHz/384 kHz) and DSD
 - AirPlay

Wi-Fi function

- Capable of WPS by PIN Method and Push-Button-Method
- Available Security Method: WEP, WPA2-PSK (AES), Mixed Mode
- Wireless LAN Standards: IEEE 802.11 a/b/g/n/ac*
 - * 20 MHz channel bandwidth only
- Radio Frequency: 2.4/5 GHz

Audio Section

Rated Output Power (2-channel driven)

(20 Hz to 20 kHz, 0.07% THD)

- | | |
|-------|-------------|
| • 8 Ω | 80 W + 80 W |
| • 4 Ω | 60 W + 60 W |
-

Dynamic power (IHF)

- | | |
|-------|---------------|
| • 8 Ω | 105 W + 105 W |
| • 6 Ω | 125 W + 125 W |
| • 4 Ω | 150 W + 150 W |
| • 2 Ω | 175 W + 175 W |

APPENDIX > Specifications

IEC Output Power (1 kHz, 0.07% THD, 8 Ω)	
• [Models for U.K. and Europe]	85 W + 85 W
Maximum Effective Output Power (JEITA, 1 kHz, 10% THD)	
• [Models for U.S.A., Canada, China, Korea, Australia, U.K., Europe, Russia and for Central and South America]	
• 8 Ω	115 W + 115 W
• 4 Ω	100 W + 100 W
Power Bandwidth (2-channel driven, 0.06% THD, 40 W/8 Ω)	10 Hz to 50 kHz
Damping Factor (1 kHz, 8 Ω)	150 or more
Input Sensitivity / Input Impedance (1 kHz, 100 W/8 Ω)	
• PHONO (MM)	3.5 mVrms/47 kΩ
• CD etc.	200 mVrms/47 kΩ
Maximum Input Signal Voltage	
• PHONO (MM) (1 kHz, 0.003% THD)	60 mVrms
• CD/LINE1/LINE2/LINE3 (1 kHz, 0.5% THD)	2.2 Vrms
Rated Output Voltage / Output Impedance (CD etc. Input 1 kHz, 200 mV)	
• LINE OUT	200 mV/1.0 kΩ
• SUBWOOFER OUT (30 Hz)	4.0 Vrms/1.2 kΩ
Headphone Jack Rated Output Power (1 kHz, 200 mV, 8 Ω load)	410 mV/470 Ω
Frequency Response	
• CD etc. (20 Hz to 20 kHz)	0±0.5 dB
• CD etc. (10 Hz to 100 kHz, Pure Direct ON)	0±1.0 dB
RIAA Equalization Deviation (Pure Direct ON)	
• PHONO (MM)	±0.5 dB
Total Harmonic Distortion Plus Noise (2-channel driven) (Pure Direct ON)	
• PHONO (MM) to LINE OUT (3 Vrms)	0.025% or less
• CD etc. to SP OUT (40 W/8 Ω)	0.015% or less
Signal to Noise Ratio (IHF-A Network) (Pure Direct ON)	
• PHONO (MM) (Input shorted, 5 mV)	87 dB
• CD etc. (Input shorted, 200 mV)	100 dB
Residual Noise (IHF-A Network) (Pure Direct ON)	
• SP OUT	30 μVrms
Channel Separation (JEITA, 1 kHz/10 kHz) (Pure Direct ON)	
• CD/LINE1/LINE2/LINE3	65 dB/50 dB or more

APPENDIX > Specifications

Tone Control Characteristics	
• Bass Boost/Cut	20 Hz/±10 dB
• Bass Turnover Frequency	350 Hz
• Treble Boost/Cut	20 kHz/±10 dB
• Treble Turnover Frequency	3.5 kHz

Continuous Loudness Control (Attenuation 1 kHz)	-30 dB
---	--------

Gain Tracking Error (+16.5 dB to -80 dB)	0.5 dB or less
--	----------------

FM Section

Tuning Range	
• [Models for U.S.A. and Canada]	87.5 MHz to 107.9 MHz
• [Models for Asia, Taiwan and for Central and South America]	87.5/87.50 MHz to 108.0/108.00 MHz
• [Models for U.K., Europe, Russia, Australia, China, Korea]	87.50 MHz to 108.00 MHz

50 dB Quiet Sensitivity (IHF, 1 kHz, 100% MOD.)	
• Monaural	3 μV (20.8 dBf)

Signal to Noise Ratio (IHF)	
• Monaural	65 dB
• Stereo	64 dB

Harmonic Distortion	
• Monaural	0.5%
• Stereo	0.6%

Antenna Input	75 Ω unbalanced
---------------	-----------------

AM Section (Models for U.S.A., Canada, China, Korea, Asia, Taiwan and for Central and South America)

Tuning Range	
• [Models for U.S.A. and Canada]	530 kHz to 1710 kHz
• [Models for Asia, Taiwan and for Central and South America]	530/531 kHz to 1710/1611 kHz
• [Models for China and Korea]	531 kHz to 1611 kHz

Antenna Input	Loop Antenna
---------------	--------------

DAB Section (Models for U.K., Europe, Russia and Australia)

Tuning Range	174.928 MHz to 239.200 MHz (Band III)
--------------	---------------------------------------

Support Audio Format	MPEG 1 Layer II/MPEG-4 HE-AAC v2 (aacPlus v2)
Antenna Input	75 Ω unbalanced

General

Power Supply	
• [Models for U.S.A. and Canada]	AC 120 V, 60 Hz
• [Model for Taiwan]	AC 110 V, 60 Hz
• [Models for Central and South America]	AC 110 to 120 V, 60 Hz
• [Model for China]	AC 220 V, 50 Hz
• [Model for Korea]	AC 220 V, 60 Hz
• [Model for Australia]	AC 230 to 240 V, 50 Hz
• [Models for U.K., Europe and Russia]	AC 230 V, 50 Hz
• [Model for Asia]	AC 220 to 240 V, 50/60 Hz

Power Consumption	190 W
-------------------	-------

Standby Power Consumption*

• Network Standby ON, Bluetooth Standby ON	
• Wi-Fi (5 GHz)	2.3 W
• Wired	2.0 W
• Network Standby ON, Bluetooth Standby OFF	
• Wi-Fi (5 GHz/2.4 GHz)	2.0 W
• Wired	1.8 W
• Network Standby OFF, Bluetooth Standby OFF	0.2 W
• Power OFF (the  (Power) Switch on the front panel is OFF)	0.2 W

* This product in Standby may download the new firmware via the network. In this case, the standby power consumption is increased than the shown value.

Maximum Power Consumption (1 kHz, 8 Ω, 10% THD)	
• [Models for Taiwan and for Central and South America]	380 W

Dimensions (W x H x D)	435 x 151 x 392 mm (17-1/8" x 6" x 15-3/8")
------------------------	--

Reference Dimensions (with wireless antenna upright)

* Including legs and protrusions	435 x 225 x 392 mm (17-1/8" x 8-7/8" x 15-3/8")
----------------------------------	--

Weight

9.8 kg (21.6 lb)

* The contents of this manual apply to the latest specifications as of the publishing date. To obtain the latest manual, access the Yamaha website then download the manual file.

Yamaha Global Site
<https://www.yamaha.com/>

Yamaha Downloads
<https://download.yamaha.com/>

© 2023 Yamaha Corporation

Published 09/2023 NV-B0

AV22-0002