



Platinum Series II

Product Manual

Contents

Introduction from the Technical Director	2	2-Channel Positioning	7
Company History	2	AV Positioning	7
Premium Materials for Unmatched Aesthetics	3	FX Speakers	8
Natural Leather Characteristics	3	Connecting Speaker Cables	9
Real Wood Veneers	3	Bare Wire Connection	9
Technologies	4	Banana Plugs	9
MPD (Micro Pleated Diaphragm) High Frequency Transducer	4	Spade Connectors	9
C-CAM® (Ceramic Coated Aluminium/Magnesium)	4	Wiring	9
RDT®II (Rigid Diaphragm Technology 2nd Generation)	4	Single Wiring	9
HiVe®II (High Velocity, Low Noise Reflex Port)	4	Bi-Wiring	10
ARC® (Anti-Resonance Composite)	5	Bi-Amping	10
TLE (Tapered Line Enclosure)	5	The Effects of Bi-Wiring/ Bi-Amping	10
Multi-layer Cabinet Curved Cabinet Construction	5	Running-In Your Platinum II Speakers	11
Individual Driver Grilles	5	Care and Maintenance	12
Single Bolt Though Driver	5	Tool Box	12
Unpacking	6	Upkeep of Cabinets	13
Spikes and Feet	6	Cleaning of Finished Leather	13
For Carpeted Floors	6	Removing the grilles	13
For Wooden/Hard Floors	6	Stands	13
Setting Up	7	Guarantee	13
		Specifications	14

Introduction from the Technical Director

“How can a loudspeaker be made to sound more natural? This is the question that drives our endeavor day-in, day-out. We’re motivated by the quest to eliminate distortion from the most important element in your audio system. How far we’ve come can be measured by the sound of Platinum II: the most accurate and beautiful loudspeakers Monitor Audio has ever made. Supported by painstaking analysis and a lifetime of listening, their evolution has refined our technologies, inspired new discoveries and achieved advances in every area of design - electrical, mechanical, magnetic, acoustic and aesthetic. The result is a speaker range of exceptional quality, dedicated to raising your emotional contact with music and film sound in all its natural glory. Built by audio lovers, for audio lovers, Platinum II provides our answer to the primary challenge of speaker design. To the big question we simply reply “like this!” “



Dean Hartley
Technical Director



Company History

Since 1972, Monitor Audio’s near fanatical commitment to quality in every aspect of loudspeaker design coupled with its willingness to innovate has inspired global recognition and acclaim. Daring to challenge design orthodoxy has been its signature approach.



When Monitor Audio launched its R852MD loudspeaker – the first model to incorporate a metal dome tweeter - it caused quite a stir. Until that time, most metal domes were single-metal types made from copper or titanium and virtually all sounded unconvincing. The R852 used an aluminium-magnesium alloy dome and sounded significantly better and smoother than all of its single-metal rivals. It also incorporated ferro-fluid damping/cooling of the metal voice-coil former and a vented voice coil mechanism for better heat dissipation. These radical design elements formed the basis for successive generations of C-CAM® metal domes.

By consistently refining and applying the technology, Monitor Audio has become the world’s foremost proponent of metal dome drivers. Monitor Audio designs everything in house at their world headquarters in England, so that it can optimise the incomparable blend of virtues that makes Monitor Audio loudspeakers unique: clean, dynamic sound, superior build quality and innovative design. Because they share a philosophy of excellence and a consistency of quality and voicing, loudspeakers of different types: on-wall, in-wall, floor and stand-mounting, may be used together to create the perfect acoustic blend for any room.

In the strength and depth of Monitor Audio’s evolving product portfolio, the ideal of a universal whole-house loudspeaker brand finds true expression. Decades of accumulated expertise and knowledge have refined the rare mix of innovation, reliability and sheer performance that has propelled the brand to global status and on which aficionados of music and movie sound have come to rely.

Premium Materials for Unmatched Aesthetics

Natural Leather Characteristics

All front baffles are hand upholstered using Ingleston leather supplied by Andrew Muirhead. Andrew Muirhead leather is used in exotic furniture, automotive and marine applications for the most quintessential British names.

Real leather is of course a natural material that adds a tactile sense of luxury wherever it's applied. The Inglestone leather that distinguishes the Platinum II baffles is of a premium quality and is supplied complete with the characteristics that give it individuality. These subtle hallmarks enrich the value of ownership and endow each Platinum II speaker with a unique identity. Monitor Audio Ltd. is unable to guarantee that the leather on each speaker will be identical. We can only assure you that the very best materials have been selected and used.



Real Wood Veneers

Just like a human fingerprint, no two trees are identical. Each wood grain has an exclusive aesthetic beauty that tells a story of a lifetime of growth. We use only the highest quality natural wood veneers, hand selected and pair matched from sustainable sources. Platinum II speakers are hand veneered after the cabinet structure is made, and then coated with 11 layers of clear gloss piano lacquer. These traditional techniques ensure close grain matching, and invisible veneer panel joining. The exquisite grain definition and rich colour variation provided by our Santos Rosewood and Natural Ebony veneers make a statement of quality, while blending naturally with any interior style or decor. Each cabinet is a unique and natural work of art!

Because of this, Monitor Audio Ltd. is unable to guarantee that the veneer on different pairs of speakers will be identical in colour or grain definition. We can only assure you that the very best raw materials have been selected and applied.

Please refer to page 12 for advice on care and maintenance.



Piano Ebony Real Wood Veneer



Santos Rosewood Real Wood Veneer

Technologies

MPD (Micro Pleated Diaphragm) High Frequency Transducer

AMT design was first invented by Dr Oskar Heil in the 1970s. However, all designs typically suffer from a null in the frequency response around 40kHz. Using FEA modelling techniques, Monitor Audio engineers were able to find the root cause of this null and develop a solution. This phenomenon was eliminated, allowing the driver to operate with uniform output to over 100 kHz. We call this unique innovation Micro Pleated Diaphragm (MPD).

The folded MPD diaphragm exhibits a surface area typically eight times that of a conventional dome tweeter, and around thirteen times that of a pure ribbon tweeter. This large surface area improves the conducted heat path and the open front increases the convection. The power handling is also improved by the high sensitivity of the tweeter. The AMT design also provides a constant non-reactive load to the amplifier, this means it's able to deliver power more efficiently with lower distortion.

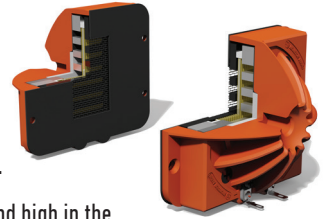

The MPD is designed to bend and does not rely on its structural integrity to extend high in the frequency range. There are no break up modes throughout the entire frequency range, exhibiting clean sonic character, free from any harmonic artefacts.

C-CAM® (Ceramic Coated Aluminium/Magnesium)

C-CAM is an innovative alloy material originally developed by the aerospace industry. It exhibits ideal qualities for use as loudspeaker cones, being extremely rigid, yet light enough to yield high overall efficiency. C-CAM is formed from an alloy of aluminium and magnesium, which undergoes stress-relieving processes in manufacturing to avoid surface deformation and molecular weakness. A layer of pure ceramic (alumina) is deposited onto the surfaces to produce a completely rigid exterior. C-CAM cones are designed to have high resistance to bending stress. When formed into a cone, C-CAM material provides increased clarity and reduced distortion compared to conventional cone materials.

RDT®II (Rigid Diaphragm Technology 2nd Generation)

RDT II is a composite 'sandwich' structure made from ultra-thin low-mass skins, bonded to a honeycomb NomexR core material. The overall thickness of the RDT II diaphragm is only 2mm, yet it exhibits 150 times the strength of a conventional loudspeaker cone. RDT II is a unique, innovative development conceived by Monitor Audio engineers for the new Platinum II series. It uses two skin materials with dissimilar mechanical properties. C-CAM is used for the front skin, while the rear skin is made from a woven carbon fibre. This combination is able to reduce distortion by over 8dB above 300Hz, which equates to a 60% reduction in the energy of harmonic components, making RDT II the lowest distortion cone technology in Monitor Audio's history.

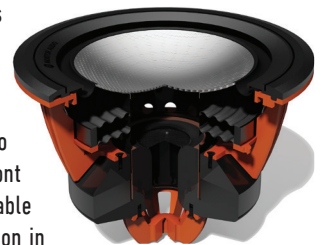

HiVe®II (High Velocity, Low Noise Reflex Port)

A new type of port technology which uses a straight rifled design to accelerate air flow and reduce turbulence. HiVe II technology has the ability to move air in and out much quicker than a conventional port, the result is fast powerful bass coupled with superior transient response.

ARC® (Anti-Resonance Composite)

A cast thermo-set polymer loaded with minerals to provide very inert, optimally damped components. This material is ideal for high-end acoustic applications where a high degree of structural rigidity and vibration damping is required. ARC is used for mid-range housings and baffle components. ARC is a unique material, developed specifically by Monitor Audio engineers for the Platinum II series. Its properties ensure energy is damped out and not emitted as high-Q resonance.

TLE (Tapered Line Enclosure)

A tapered, parabolic-shaped enclosure cast from ARC material and designed to prevent the propagation of standing waves and modal resonances. The tapered shape also has the effect of attenuating high frequencies: smaller waves being suppressed with the use of graduated damping materials. TLE is a unique design developed specifically by Monitor Audio engineers for the Platinum series II.

Multi-layer Cabinet Curved Cabinet Construction

Platinum II cabinets are hand built using multiple laminations of wood veneers and shaped using complex curves to form a rigid shell. Curved surfaces are inherently stronger than flat surfaces. Since internal sides are non-regular curvatures, standing waves (loosely defined as internal reflections) cannot be set up.

New internal bracing structures have been developed to ensure the ultimate in structural integrity, as well as serving to break up long acoustic paths internally. Instead of large open spaces internally, we now have small, dedicated compartments and chambers. This further reduced the prospect of standing waves, and is particularly efficient at lower frequencies.

Bitumastic internal damping material is applied to all internal cabinet walls, ensuring that any residual energy is damped out. The resulting homogenous enclosure is supremely rigid, acoustically inert and able to deliver the sound as it was intended, natural and uninhibited.

Individual Driver Grilles

Drivers are covered by individual grilles, designed to be acoustically transparent. The system will therefore sound just as good whether the grilles are on or off.

Single Bolt Through Driver

All Platinum II drivers feature a unique single bolt-through driver fixing system. Each driver is fixed into to the cabinet from the rear using a long bolt tightened to a specific torque setting during production. The bolt serves to provide the driver with an equal clamping force around the periphery, whilst ensuring the motor system is braced. Since this is effectively an additional form of bracing, the cabinet system with drivers installed becomes even more rigid.

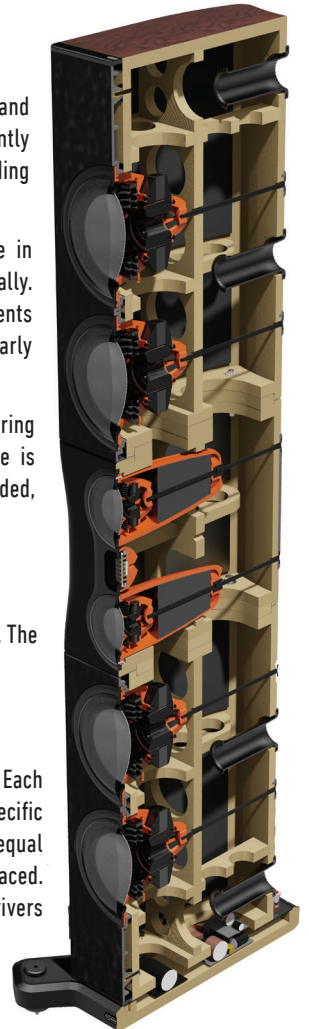

Unpacking

Before you unpack your speakers, please make sure that there is plenty of clean floor area available. Pictorial guides printed on the outer transit carton show you the ideal method for unpacking. Please see below for more information.



WARNING: DO NOT attempt to lift any of the speakers alone. The recommended number of people is printed on the outer carton.

For all speakers (except the PL300 II and PL500 II): Lay the box down on the floor so the opening is on the side facing up. Open the outer carton and then use the handles of the inner cardboard sleeve to lift the speaker and packaging out of the box. Remove the polystyrene end caps and fit the feet/spikes (where applicable). Please refer to the Spikes and Feet section below.

The PL300 II and PL500 II: Should be unpacked standing upright, the top of the speaker is indicated on the carton. Open the carton and use the holes provided in the cardboard tray at the base of the speaker to pull the speaker out of the carton. The sleeves at the side can be used also to steady the speaker and assist pulling. Once the speaker is out remove the top polystyrene cap. Tilt the Speaker to remove the base polystyrene caps and protective cloth. The PL500 II has easy-slide feet attached to the bottom of the plinth. These enable easy positioning of the PL500 II. They work on all floors and will not scratch. If the carpet is very thick, these may not work as effectively and the cabinet will need to be "walked" into position. Once positioned the spikes/feet can be added by tilting the cabinet as previously described, please refer to the Spikes and Feet section below.

Spikes and Feet

For Carpeted Floors

(PL200 II, PL300 II and PL500 II only)

The feet are supplied pre-assemble for use on carpeted floors or where spikes are appropriate. All you need to do is fix them into the plinths. This is achieved by screwing the feet fully into the 4 threaded holes in the plinth. They are then secured using the large locking nuts provided.

You can check that the speaker is level on all sides by using the levelling tool provided in your tool kit. If it's slightly off-level, unscrew the foot at the lowest point and check again. Continue this process until the cabinet is fully level. Use the locking nuts on each foot to fix the feet in place and to stop any unwanted vibrations.

Please ensure there are no hidden wires under the carpet that could be damaged by the spikes.

For Wooden/Hard Floors

(PL200 II, PL300 II and PL500 II only)

If the speaker is being installed on a hard/wooden floor, remove the spike from the foot assembly as illustrated.

You can check that the speaker is level on all sides using the levelling tool provided in your tool kit. If it's slightly off-level, unscrew the foot at the lowest point and check again. Continue this process until the cabinet is fully level. Use the locking nuts on each foot to fix the feet in place and to stop any unwanted vibrations.

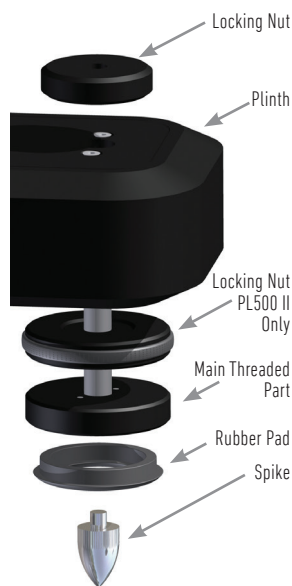

Setting Up

2-Channel Positioning

When arranging a 2-channel system, the listening position and the loudspeakers should form an equilateral triangle. The speakers should be positioned approximately 6 - 10 feet (1.8 - 3m) apart. The ideal distance from the rear wall varies depending on the speaker (see guide below), however, the speakers need to be a minimum of 3 feet (91cm) from the side walls.

- Platinum 100 II: 8 - 18 inches (20 - 45cm)
- Platinum 200 II: 18 - 24 inches (45 - 60cm)
- Platinum 300 II and 500 II: up to 36 inches (91cm)

When setting up the speakers, experimentation is strongly advised, as environmental acoustics and personal preference differ with every installation. If there is insufficient bass present for example, try moving your speakers closer to a wall. The opposite approach is recommended if there is excessive bass. In addition, please see the information on the supplied USB referring to port bungs. If stereo imaging is being lost, try 'toeing-in' the speakers slightly. The sound should appear to originate from the centre point between the speakers, not the speakers themselves.

AV Positioning

Please refer to the illustration below and on page 8 for the ideal angles and positions of each speaker in your surround system. The speakers should be distanced from the wall according to the requirements of the speaker, which are listed in the 2-Channel Positioning section (page 7).

If the sound is too bass heavy or there is bass boom from the room when playing music (without a subwoofer), try moving the loudspeakers slightly further away from the wall(s) or adjusting the crossover frequency settings for the speakers and/or sub. Also try changing the subwoofer's position. If this is not possible, then try the supplied port bungs. Please refer to the full manual on the supplied USB for more information.

The Platinum II Centre channel speaker should be positioned so that it is pointing at the viewing position and at approximate ear height. If it is below or above ear height, use the rubber feet supplied to angle it slightly



An example of a Platinum 7.1 system consisting of PL300 II front Left/ Right, a PLC350 II centre channel and PL100 II surrounds.

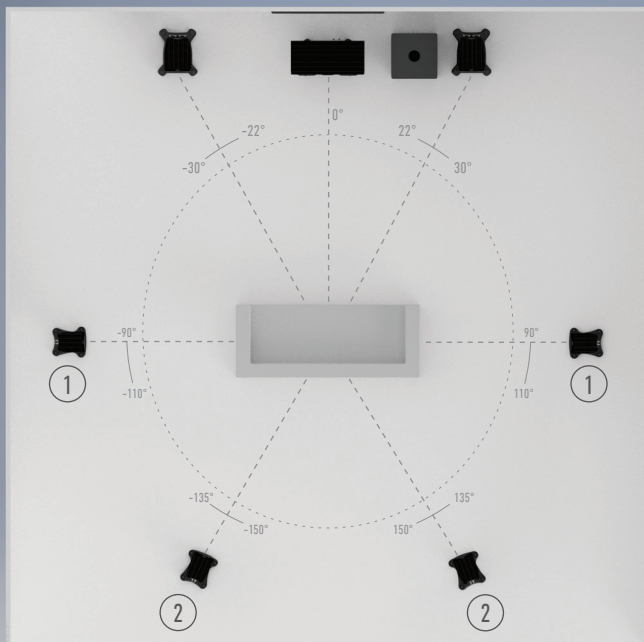

1. Side surround speakers
2. Rear surround speakers

A 7.(1) surround system will make use of side (position 1) and rear (position 2) speakers to create a full 360° soundstage, if setting up a 5.(1) system you can place your surrounds in position (1) or (2).

FX Speakers

If you wish to use FX speakers in an AV system with Platinum Series II we would recommend the Gold FX, which not only will be a good timbre and tonal match with your Platinum II speakers but is also available in the same selection of high quality finishes. The FX can also be flush-mounted on side or rear walls.



The Gold FX in high gloss Piano Black

When compared to a traditional surround speaker the FX offers the addition of spatial sound dispersion through the use of side firing tweeters which can be used in Di-Pole (spatial sound) or Monopole (direct firing) mode.

For more information on the Gold FX please refer to our website:
www.monitoraudio.com

Connecting Speaker Cables

Bare Wire Connection

Unscrew the binding posts and pass the bare wire through the hole in the binding post. Tighten the binding post to clamp the wire in place.

Banana Plugs

Remove the red and black plastic plugs from the terminals and insert the banana plugs into the standard 4mm holes that are revealed. Pliers may be required to gain purchase on the plugs.

Spade Connectors

Unscrew the binding post and place the spade connector around the exposed thread. Tighten the binding post to clamp the spade connector in place.

Wiring

Single Wiring

Single wiring is achieved by using a single set of cables to the terminals on the back of the speaker. Internally the speaker crossover guides the frequencies to the appropriate driver/tweeter - low frequencies to the bass drivers, mid frequencies to the mid/bass drivers and high frequencies to the tweeter.

It is perfectly acceptable to connect to the HF or LF terminals, or to split LF/HF (experimentation is advisable to achieve the preferred results).

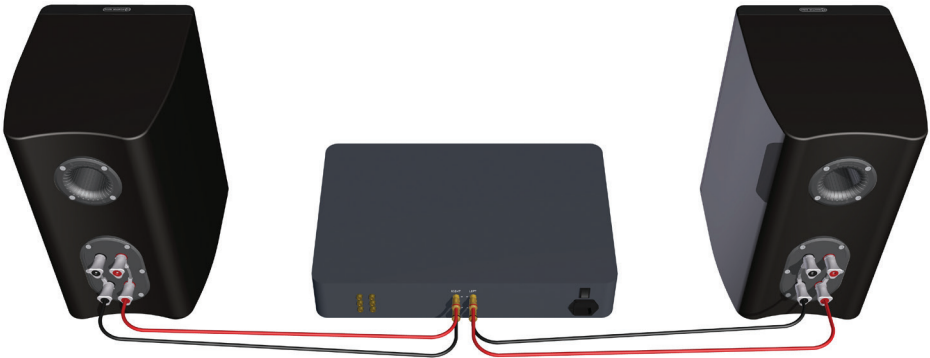

NOTE: When using this method you must KEEP the terminal links in place.

Bi-Wiring

Bi-wiring is accomplished by connecting separate pairs of speaker cables to the terminals on the loudspeaker from a single pair of connections on the amplifier. In the case of the Platinum II Series, the LF terminals connect to the bass driver(s) and the HF terminals connect to the tweeter (in 2-way loudspeakers), or the mid and tweeter in 2.5 and 3-way speakers.

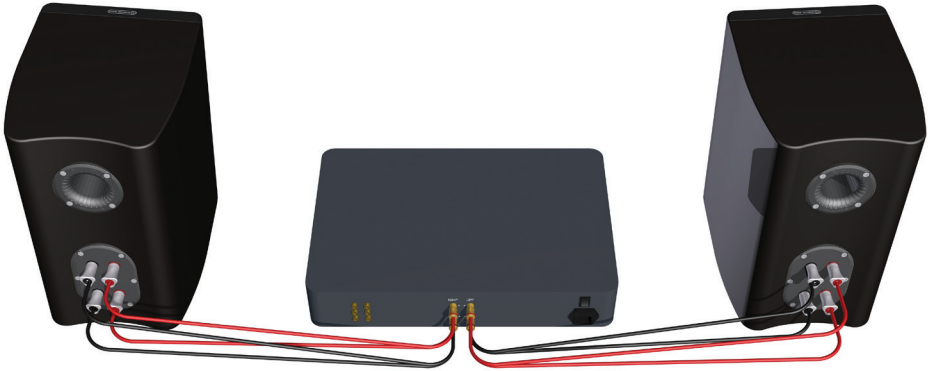

NOTE: When using this method the terminal links MUST be removed.

Bi-Amping

Bi-Amping is the same as Bi-Wiring except that you are introducing a second amplifier into the equation. In order to Bi-Amp you must connect a set of speaker cables to the HF terminals on the loudspeaker from one amplifier and another set of speaker cables to the LF terminals from the second amplifier.

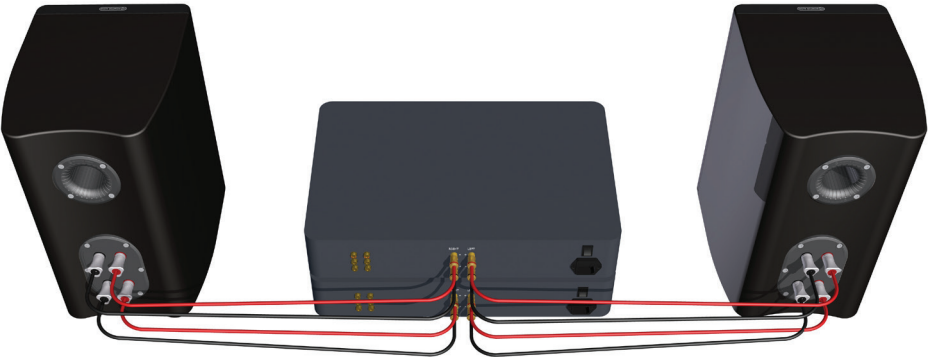

NOTE: When wiring this method the terminal links MUST be removed.

The Effects of Bi-Wiring/ Bi-Amping

Fundamentally a loudspeaker crossover varies the impedance seen by the speaker and by the power amplifier. The situation is such that when the full range musical signal is applied to the terminals of a full-range speaker system, the bass driver(s) only receives low frequency signals, the mid driver receives the mid band frequency signals and the

tweeter only gets sent high frequency signals. This means that if separate speaker cables are connected to the low frequency terminals, and the high frequency terminals, not only have the drive units and the frequency's directed and divided for them, but the two separate speaker cables will now also carry different signals, the bass cable mostly the lows, and the tweeter cable mostly the highs.

In a single wired system, unwanted mechanical and electrical resonances manifest as distortion at both sets of speaker terminals. Due to the impedance of the speaker cables, these distortions will not be entirely cancelled by the amplifier. Instead, they modulate between the two crossovers, and degrade sound quality. When bi-wiring, this interaction is minimised as signal distortion is 'seen' at the amplifier's output where it can be more effectively cancelled. Bi-wiring/ bi-amping therefore presents a 'cleaner' signal at both the low frequency and high frequency speaker terminals, and because the high and low frequencies have already been separated, each has a minimal effect on the other - in essence the bass does not overpower delicate treble.

In terms of the audible benefit, bi-wiring/ bi-amping, provides more clarity and detail to the midrange and high frequencies. Often the bass will become faster and tighter. Focus and staging will improve as well. In all, this is a very effective and desirable improvement and is highly recommended by Monitor Audio.

Running-In Your Platinum II Speakers

Run your speakers in by playing normal music or by using our running-in CD: the System De-Tox Disk, at low-mid listening levels for approximately 50-70 hours play time. You may find the sound will continue to improve even after the 70 hour mark.

This can be done naturally over time: like a fine wine the performance will improve with age.

Alternatively if you wish to run the speakers continuously on loop you can decrease the audible volume/presence by placing the speakers face-to-face so that the drivers/tweeters are directly aligned and as close as possible. Then connect the amplifier to your speakers so that one is as normal (in phase): positive to positive and negative to negative (red to red and black to black), and the other speaker out of phase: positive to negative and negative to positive inputs on the speaker.

For information on Monitor Audio's System De-Tox disk please refer to our website: www.monitoraudio.com



Care and Maintenance

Tool Box

1. Allen/ Hex keys: 5mm (feet adjustment), 8mm (driver bolt tightening), 10mm (mid-range bolt tightening)
2. Grille removal tool
3. USB drive (Platinum Series II Manuals and Monitor Audio SubConnect application)
4. Spirit level

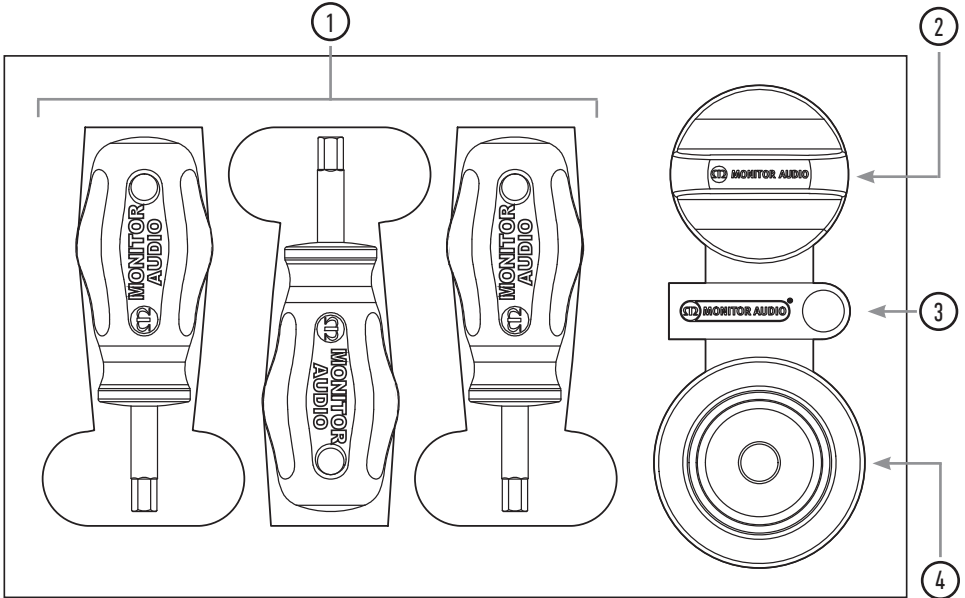

Upkeep of Cabinets

The high gloss finish of the cabinet can be maintained by regular dusting using a soft cloth or micro fibre cloth. When the finish needs to be revived a high-quality, non-abrasive, automotive wax or polish can be used. The drive units should only be cleaned with a damp cloth if more than normal dusting is required.

Never use solvents or aggressive cleaning/polishing agents on your Platinum II speakers. When in doubt, test the cleaning product on an inconspicuous area on the cabinet and let it sit for several days before committing to its use on visible portions of the cabinet.

Cleaning of Finished Leather

Cleaning of leather is perhaps something that is given too much emphasis. Leather furniture in a normal domestic environment should require little attention and any cleaning should be done only when necessary. However, an accumulation of dirt and grease over a long period is undesirable and obviously, the longer it is left the more difficult it will be to remove. Dirt is abrasive and over a period of time in extreme circumstances will cause the removal of the protective coating.

For regular cleaning, use a cloth soaked in a mild soap/water solution (not detergent) and wring it out until damp. Apply the cloth to the surface of the leather in a light circular motion, turning the cloth regularly. Avoid an aggressive rubbing action. Repeat with a damp cloth rinsed in clean warm water. To improve the life of the leather, we recommend the use of high quality leather conditioners and cleaners such as those commonly found in automotive centres. Do not use abrasive furniture cleaners on your Platinum II speakers.

Removing the grilles

All Platinum II speakers apart from the PLW215 II feature individual driver grilles, which come factory fitted. If desired these can be removed using the grille removal tool found in the Platinum II Tool Box (refer to page 12).

To remove the grilles simply place the magnetic face of the grille removal tool on the outer edges of the grille. Gradually prise the grille off, by using the tool at various positions around the outer edge of the grille.



Stands

New dedicated Platinum Series II stands are available, to perfectly compliment both aesthetically and acoustically with the PL100 II stand mount speakers. They feature sturdy 'no ring' construction to add safe support and isolate the speakers from resonant frequencies. The new stands' height has again been optimised for listening, aligning the speakers tweeters at ideal ear height within a seated listening position. For more information please visit our website: www.monitormedia.com

Guarantee

Both the craftsmanship and the performance of this product is guaranteed against manufacturing defects for the period of **five** years for speakers and **two** years for the PLW215 II from the date of purchase (see conditions in the Important Safety Instructions booklet), provided that the product was supplied by an authorised Monitor Audio retailer under the consumer sale agreement.

To verify your manufacturer's warranty, please visit the online registration form at: www.monitormedia.com

Specifications

	PL100 II	PL200 II	PL300 II	PL500 II	PL150C II	PL350C II
System Configuration	2 Way – 2 driver	3 Way – 4 driver	3 Way – 4 driver	3 Way – 7 driver	2.5 Way – 3 driver	3 Way – 4 driver
Frequency Response.	40Hz – 100kHz	35Hz-100kHz	28Hz – 100kHz	22Hz- 100kHz	45Hz-100kHz	32Hz- 100kHz
Sensitivity (1W@1M).	88dB	90dB	90dB	91dB	89dB	90dB
Nominal Impedance	6 Ohm (4.5 Ohm Min @ 160Hz)	4 Ohm (4.0 Ohm Min @ 135Hz)	4 Ohm (4.2 Ohm Min @ 111Hz)	4 Ohm (4.2 Ohm Min @ 120Hz)	6 Ohm (4.5 Ohm Min @ 170Hz)	4 Ohm (4.0 Ohm Min @ 115Hz)
Maximum SPL (per pair, in room)	111.8dBA	117dBA	117.8dBA	120dBA	112dBA	114dBA
Power Handling (RMS)	120W	250W	300W	400W	200W	250W
Recommended amplifier power into 4 Ohms (RMS)	60-120W	100-250W	100-300W	150-400W	60-200W	100-250W
System Alignments	Single rear HiVe®II port technology	Two HiVe®II ports technology Sealed Mid-range TLE enclosure	Two HiVe®II ports technology Sealed Mid-range TLE enclosure	Four HiVe®II ports technology Sealed Mid-range TLE enclosure	Single rear HiVe®II port technology	Two HiVe®II ports technology Sealed Mid-range TLE enclosure
Mid - H.F Crossover Frequency	3.0kHz	3.9kHz	3.4kHz	3.6kHz	3.0kHz	3.3kHz
Bass - Midrange Crossover Frequency	N/A	750Hz	500Hz	460Hz	600Hz (-6dB LF)	780Hz
Drive unit Complement	1 x 6.5" RDT®II bass/mid- range driver 1 x MPD high frequency transducer	2 x 6.5" long-throw RDT®II bass drivers 1 x 4" RDT®II mid-range driver 1 x MPD high frequency transducer	2 x 8" long-throw RDT®II bass drivers 1 x 4" RDT®II mid-range driver 1 x MPD high frequency transducer	4 x 8" long-throw RDT®II bass drivers 2 x 4" RDT®II mid-range driver 1 x MPD high frequency transducer	1 x 6.5" RDT®II bass driver 1 x 6.5" RDT®II bass/ mid- range driver 1 x MPD high frequency transducer	2 x 8" long-throw RDT®II bass drivers 1 x 4" RDT®II mid-range driver 1 x MPD high frequency transducer
External Dimensions (Including Fixed Plinth where applicable) (H x W x D)	370 x 225 x 285 mm 14 ⁹ / ₁₆ x 8 ⁷ / ₈ x 11 ¹ / ₄ inch	998 x 360 x 375 mm 39 ⁵ / ₁₆ x 14 ³ / ₁₆ x 14 ³ / ₄ inch	1113 x 410 x 470 mm 43 ¹³ / ₁₆ x 16 ¹ / ₈ x 18 ¹ / ₂ inch	1803 x 504 x 626 mm 71 x 19 ¹³ / ₁₆ x 24 ⁵ / ₈ inch	225 x 583 x 291.2 mm 22 ¹⁵ / ₁₆ x 8 ⁷ / ₈ x 11 ⁷ / ₁₆ inch	288 x 800 x 368 mm 11 ⁵ / ₁₆ x 31 ¹ / ₂ x 14 ¹ / ₂ inch
External Dimensions (Including Fixed Plinth, Feet and Spikes where applicable) (H x W x D)	N/A	1043 x 360 x 375 mm 39 ⁵ / ₁₆ x 14 ³ / ₁₆ x 14 ³ / ₄ inch	1158 x 410 x 470 mm 43 ¹³ / ₁₆ x 16 ¹ / ₈ x 18 ¹ / ₂ inch	1848 x 504 x 626 mm 71 x 19 ¹³ / ₁₆ x 24 ⁵ / ₈ inch	N/A	N/A
Product Weight kg (lbs)	14.94Kg (32lb 14oz)	36.08Kg (79lb 6oz)	54.52Kg (120lb)	99.1Kg (218lb)	23.98Kg (52lb 12oz)	43.02Kg (94lb 10oz)
Finishes Available	Santos Rosewood veneer with piano lacquer. Ebony veneer with clear piano lacquer or Piano Black lacquer. Upholstered front baffle in Black Ingleston premium grade leather By Andrew Muirhead.					

Monitor Audio reserves the right to alter specifications without notice.



Monitor Audio Ltd.
24 Brook Road
Rayleigh, Essex
SS6 7XJ
England
Tel: +44 (0)1268 740580
Email: info@monitoraudio.com

monitoraudio.com