

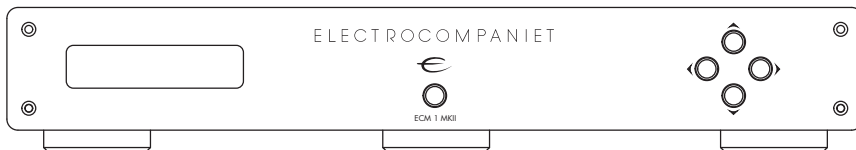

ELECTROCOMPANIET

If music *really* matters™



## ECM 1 MKII

*Balanced Network Music Player  
with built-in DAC*

---

**Owner's Manual**

---



ENGLISH



---

## Welcome to the world of Electrocompaniet!

We thank you for choosing an Electrocompaniet high-end product.

At Electrocompaniet we are relentlessly focused on developing audio equipment that is capable of bringing the fabulous experience of the concert hall into the very heart of your home.

Our aim when developing and testing new products is to ensure that the wonderful richness of tone and every nuance of feeling and emotion of a piece of music is delivered to you just as the artist intended.

We constantly strive to provide you with the very best musical listening experience, no matter what music genre you prefer.

Sincerely yours,  
The Electrocompaniet team



---

## Unpacking the ECM 1 MKII

Immediately upon receipt of the ECM 1 MKII, inspect the carton for possible damage during shipment. The carton and packaging have been designed to provide the safest possible protection for transport of your network music player. Unpack the unit carefully. Save all packaging materials for future shipment.

### The contents of the carton

- 1 pc. Electrocompaniet ECM 1 MKII Network Music Player.
- 1 pc. AC main cord.
- 1 pc. Inspection card.
- 1 pc. Owner's manual.
- 1 pc. IR Remote control.

### Set up procedure

Before connecting the ECM 1 MKII to the AC Power outlet, check that the main voltage selector on the rear panel corresponds to the line voltage in the country were you intend to use the unit. (See illustration "rear panel", page 5.)

### How to avoid damages

Do not under any circumstances connect or disconnect equipment when power is turned on. The design of the RCA plug generates a huge transient when inserted. Connecting or disconnecting equipment with the power on can result in severe damage to both speakers and amplifier.

### How to avoid noise problems

The ECM 1 MKII contains delicate circuits that are sensitive to magnetic stray fields. The unit should not be placed near power voltage transformers, TV sets etc. Care should also be taken regarding placement of the interconnect cables. Do not run interconnect cables in parallel with main cords or speaker cables. Keep interconnect cables as short as possible.

### How to avoid possible antenna problems

In some set-ups hum may occur when you connect the radio, VCR or TV to your system. The problem is caused by DC voltage offset coming from your antenna system. Please contact your cable network operator.



## Front panel overview

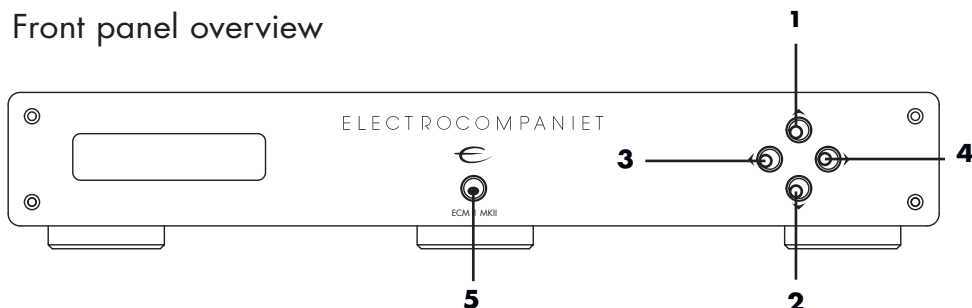

Nr.	Button	Function	Description
1	UP	Volume Up	Increases the volume level.
2	DOWN	Volume Down	Decreases the volume level.
3	LEFT	Select source left	Selects the next source to the left.
4	RIGHT	Select source right	Selects the next source to the right.
5	STANDBY	Standby mode	In daily operation, switch off the ECM 1 MKII by using the STANDBY button

## Navigator window

The display shows the active input, the sample rate/bit depth and the volume setting. The display has two display modes: Input and Status.

## Input display mode

Audio Source	Display Text	Description
COAX 1	COAX1	Coaxial S/PDIF input up to 192 kHz/24 bit
COAX 2	COAX2	Coaxial S/PDIF input up to 192 kHz/24 bit
TosLink 1	TOSLNK1	Optical S/PDIF input up to 192 kHz/24 bit
TosLink 2	TOSLNK2	Optical S/PDIF input up to 192 kHz/24 bit
Bluetooth	BT	Streaming from connected bluetooth device
LAN/Wi-Fi	Streaming service name	If audio source is LAN/WiFi, the display text shows the current source (e.g. Music, Tidal, Spotify, etc.)

## ENABLING Bluetooth®



From within the app, go to More (...) -> Bluetooth to enable pairing. The red LED on the front panel flashes to indicate the unit is in pairing mode. Go to your phone or tablet's Bluetooth settings to find your unit and connect to it. Subsequent connections from the paired device will not need pairing to be enabled.



## Status display mode

The display shows the volume setting and sample rate for the selected input. The display enters into "status" mode when the volume control is operated and when new input is activated, input or the sample rate is changed. After 5 seconds the display will revert back to the INPUT mode. In "status" mode the following information is displayed: The first part shows the current sample rate of the input and the last number shows the volume level. Sampling rate is only shown for external/DAC inputs. For streaming services, the status mode does not show the sampling rate. The volume ranges from 0 to 100.

192kHz 100

## Rear panel overview

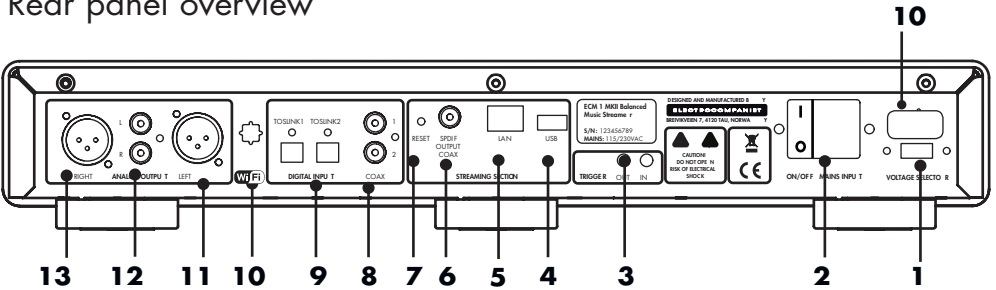

Nr.	Name	Used for	Connection type/Cable
1	Voltage	Selecting input voltage 110/240V	N/A
2	Power / AC Input	Power ON/OFF button. Input power	Supplied power cable
3	Trigger in/out	12V trigger control in-/output	3,5mm mono mini jack
4	USB input	External usb storages	USB
5	LAN	Network conection	RJ 45/ Cat 5 or higher
6	SPDIF	Coaxial digital audio output (SPDIF)	Coaxial digital cable
7	Reset	Reset of the unit to factory settings	N/A
8	Coax input 1/2	Coaxial digital input	Coaxial digital cable
9	Toslink inputs 1/2	Optical digital audio input	TOSLINK / optical cable
10	Wireless antenna	Wireless connection	N/A
11	XLR output left	Balanced audio connection	XLR / balanced audio cable
12	RCA output Left/ Right	Unbalanced audio connection	RCA / unbalanced audio cable
13	XLR output right	Balanced audio connection	XLR / balanced audio cable



## REMOTE CONTROL

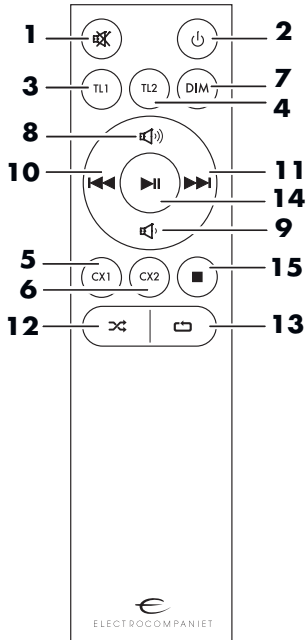

1. Mute - on/off.
2. Standby button.
3. DAC input selector: TOSLINK 1.
4. DAC input selector: TOSLINK 2.
5. DAC input selector: COAX 1.
6. DAC input selector: COAX 2.
7. DIM - dimming the display.  
*\* Keep in mind that the display can be dimmed to zero brightness.*
8. Volume UP.
9. Volume DOWN.
10. Previous track.
11. Next track.
12. Shuffle.
13. Repeat.
14. Play/Pause
15. Stop.

### Replacing batteries

Use 1pc CR2032 battery. Observe correct polarization when inserting battery. Please remove battery when the remote is not used for a prolonged period of time.

### IR Remote control codes ( page 16)

### Using the remote

When using the remote control, the front end of the remote control should be pointed to the front panel of your ECM 1 MKII. A free line of sight is required between the remote and the infrared sensor on the front panel.



## HOW TO CONNECT YOUR SYSTEM ( *illustration "rear panel", page 5.*)

### SPDIF inputs ( *See illustration "back panel", page 5.*)

ECM 1 MKII will accept optical SPDIF sources up to 192kHz/24bit on inputs TOSLink 1 and TOSLink2. Please use a optical TOSLink cable for this connection. Connect coaxial sources up to 192kHz/24bit to inputs COAX1 and COAX2. Please use a coaxial SPDIF cable for this connection.

### Analog audio output – balanced XLR

Use the balanced XLR connectors if you have an amplifier equipped with balanced XLR audio inputs. Connect the balanced XLR audio outputs from your ECM 1 MKII to the balanced XLR audio input on your amplifier. Observe correct connection on right and left audio channel.

### Analog audio output – unbalanced RCA

Use the unbalanced RCA connectors if your amplifier is not equipped with balanced XLR audio inputs. Connect the unbalanced RCA audio outputs from your ECM 1 MKII to the unbalanced RCA audio input on your amplifier. Observe correct connection on right and left audio channel.

### 12V trigger Input/Output ( *See illustration "rear panel", page 5.*)

Your ECM 1 MKII is equipped with trigger input and trigger output ports. These ports can be used for automatically putting your ECM and other equipment into, or wake up from, standby mode. Use the trigger input port for connecting to a trigger output signal from other equipment. The ECM 1 MKII will power up (leave standby mode) when a voltage in the range of 8V-20V (AC or DC) is detected on the trigger input port, and will remain powered on for as long as the voltage is present on the trigger input port.

#### NOTE:

The ECM 1 MKII will only react to a change in the trigger signal.

When the detected trigger signal goes from low to high, ECM 1 MKII will wake from standby.

When the detected trigger signal goes from high to low, ECM1 will go into standby.

A low trigger signal is defined as less than 1V (AC or DC).

A high trigger signal is defined as more than 8V(AC or DC). The voltage supplied to the trigger input must not exceed 20V (AC or DC). A trigger signal is not mandatory to operate the ECM.



Use the trigger output to send the trigger signal to your amplifier, TV, projector or other equipment that support trigger signals. This signal can be used to automatically switch on/off the connected equipment when you turn on/off your ECM 1 MKII. Trigger output is 12V DC. Use a 3,5mm mono jack plug for connecting to trigger input and trigger output.



## LOCAL DISC INSTALLATION

Your ECM 1 MKII supports adding an internal hard drive or SSD for storing audio files. A drive with a SATA interface is required for this connection. Both 3,5" and 2,5" drives can be mounted.

### WARNING!



The disk will be automatically formatted for use. All data on the drive will be lost. If a hard drive is installed it will be turned off when not in use. This prevents vibrations from negatively influencing audio playback quality. ECM 1 MKII has no limitation for internal disk capacity.

### How to install internal hard drive

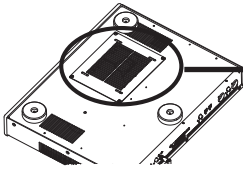

1. Flip the ECM 1 MKII

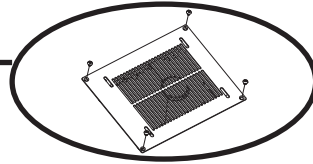

2. Remove screws and take out the HDD holder

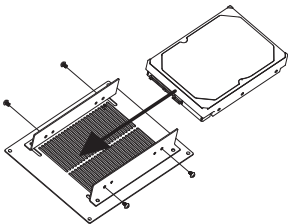

3. Insert the HDD (3,5" or 2,5")

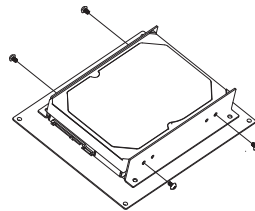

4. Tighten the screws

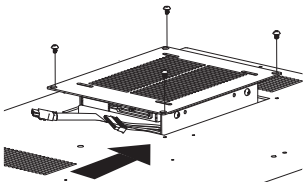

5. Connect the wires

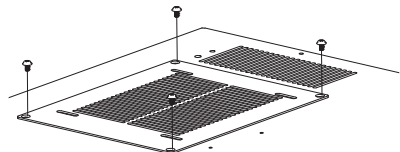

6. Tighten the screws





## FIRST TIME SETUP

Your ECM 1 MKII is equipped with a setup guide that quickly configures the most common settings. In order to access this guide, the ECM 1 MKII should be connected to your network by ethernet cable. (not included)

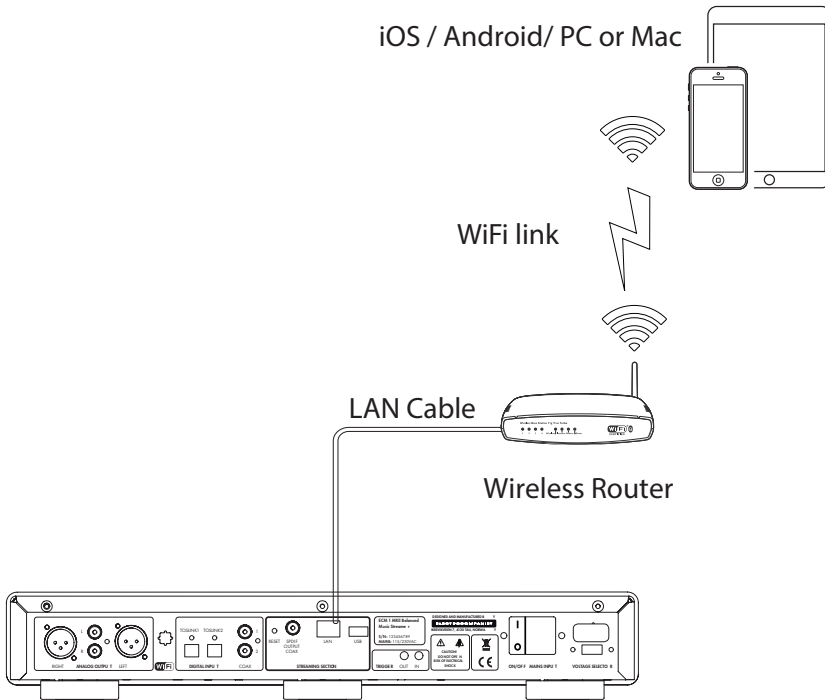

*If you don't have access to a router or can't connect the system using an Ethernet cable, please go to page 14 to set up the system wirelessly."*



# INITIAL SETUP PROCEDURE WITH A CABLE CONNECTION

## The first time you set up your ECM 1 MKII

### RECOMMENDED

#### Download the "EC PLAY" App

The free App is available at Apple store or Google Play. Search for: "EC PLAY" or "Electrocompaniet"



OR

Use your PC, Mac or Linux machine with a web browser

#### Connect to your router

In order to establish a Wi-Fi connection you have to use a LAN cable which connects to you local network, or directly to your router.

*\*LAN cable is not included. Please use any standard RJ45 cable.*

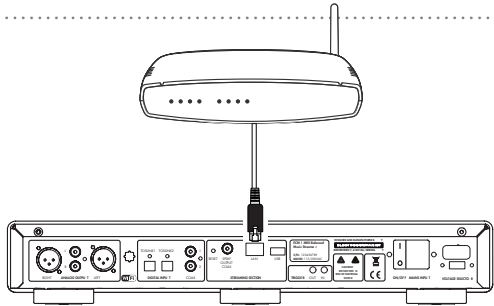

#### Connect the power cable

Power up the ECM1 MKII by connecting the power cable included in the box and flipping a power on button at the back panel.

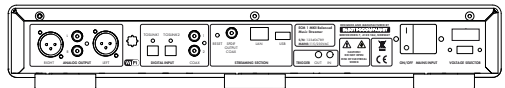
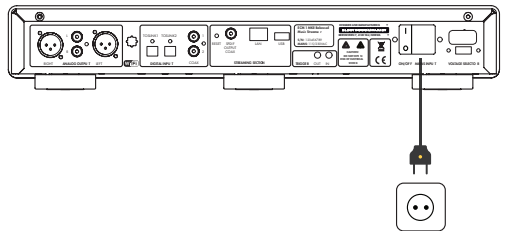



## FOLLOW THE ON-SCREEN INSTRUCTIONS

### RECOMMENDED

#### Start your “EC PLAY” App

As long as you have downloaded the App following the previous instructions, you will find the App where you normally find other Apps on your device.

1. Start the App.
2. Press the “setup a new system” in the app. Follow the on-screen instructions in the app to setup your system.

OR

### ALTERNATIVE

#### Use a web browser

Enter the address of your ECM 1 MKII in the web browser.  
If you are using a Mac or Linux machine, this will be “ECM1-<number>.local”.  
Where <number> is the last 4 digits of the serial number, excluding leading zeros (e.g. “ECM1-565.local”).

On a PC, please enter the system’s IP address. You may find this address in your router, by referencing the ECM 1 MKII MAC address. Please follow your router manufacturer’s instructions for finding an IP address given a MAC address.



### You are done, tap FINISH to complete

You have now completed the setup of your system.  
For test, please select **Radio** from the main screen.  
Select *Top100* stations and pick a station to test the system.



## ENABLING WIRELESS CONNECTION

*This step is only necessary if you want the system connected to your wireless network. If you want to continue using wired connection (LAN cable), simply skip this page. (We recommend using wired connection if possible to reduce Wi-Fi traffic and achieve best possible network stability for the system.)*



### NOTE:

There is no benefit in connecting both WiFi and cable. Please only use one or the other.

### Wireless network setup:

1. Start the EC PLAY App.
2. Tap **MORE button** at the bottom right menu.
3. Tap **NETWORK**.
4. Scroll down and tap **CONFIGURE WIFI**.
5. Select your wireless network. (Mobile/tablet must be on the same network)
6. Enter your password, tap "Join" or "OK"
7. Remove the LAN cable and wait until the Rooms button appear.  
Tap Room and reselect your ECM 1 MKII.

*If you loose connection with the system, reconnect the network cable and check your network password carefully.*

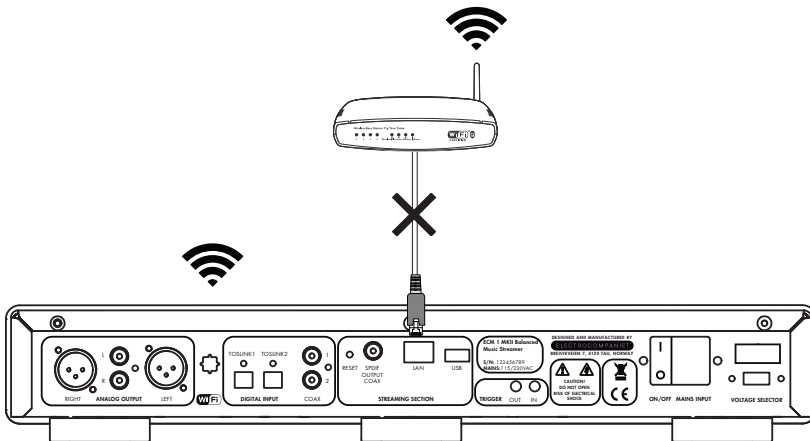



## PERFORMING THE INITIAL SETUP WIRELESSLY

*The first time you set up your ECM 1 MKII Network Music Player.*

If you haven't been able to perform the setup via ethernet cable (recommended). Then please follow the steps below. Otherwise, please skip this page.

### RECOMMENDED

#### Download the "EC PLAY" App

The free App is available at Apple store or Google Play. Search for: "EC PLAY" or "Electrocompaniet"



OR

Use your PC, Mac or Linux machine with a web browser

#### Connect the power cable

Power up the ECM 1 MKII by connecting the power cable included in the box and pressing a power on button at the back panel.

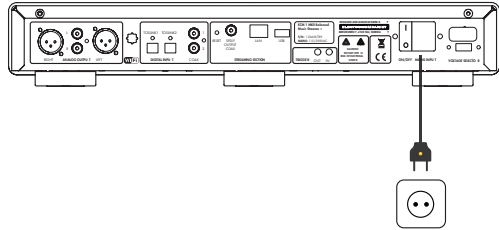

### RECOMMENDED



#### iOS Apple devices:

1. Go to settings -> WiFi.
2. Wait until you see on the right side an entry under "SET UP NEW AIRPLAY SPEAKER" on the lower part of the display. The unit will appear as ECM 1 MKII - <serial nr.>. Select it. Follow the steps on screen.  
( Leave the password empty )
3. Start the EC PLAY App and follow on-screen instructions.



#### Android devices:

1. Go to settings -> WiFi
2. Select the system access point in your Wi-Fi settings. The access point will be named after your system and serial number. For example, "ECM1 -10",
3. Start the EC PLAY App and follow on-screen instructions.

OR



## ECM 1 MKII STATUS INDICATORS

There are three status LEDs indicating the status of your system.

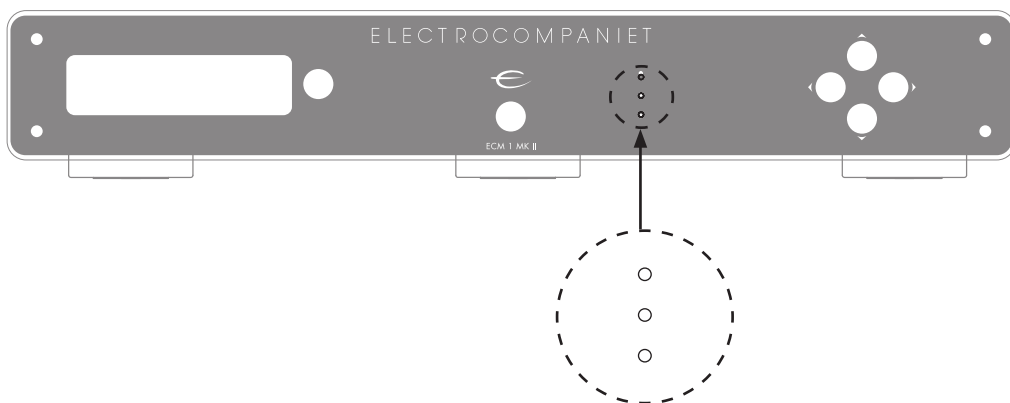

### Status LED indicators

	<b>System state</b>	<b>Led state</b>	<b>Colour</b>
	Start-up	Flashing fast, then on only for 10s	Green
	Scanning library	Flashing slow. Will turn off when the scanning is completed	Green
	No network	Solid	Orange
	Updating firmware	Heartbeat flashing pattern	Orange
	Overtemperature	Flashing fast	Red
	Bluetooth pairing	Flashing fast for 1 minute	Red
	Recovery	Solid	Red
	Recovering USB	Solid	Green/Red
	Ready for Airplay WAC setup	Solid	Green



## TIPS AND TROUBLESHOOTING

### Streaming from Apple devices

On Apple devices, it is possible to stream all audio from your iPhone/iPad to the ECM 1 MKII via "Airplay". This is represented by this symbol 

We do not recommend using this system playing from Spotify, Qubuz and Tidal. Instead, use our EC PLAY App to control playback.

For Spotify, use Spotify connect, as represented in the Spotify App by the device icon.  This will allow the ECM 1 MKII to stream directly from the internet, which optimizes the bandwidth, and saves battery life on your iPhone/iPad.

### Connecting to WiFi

We recommend that the ECM 1 MKII has a link quality of minimum 70%, and better than 40 Mb/s link speed. This can be verified in our App, in the More -> Network menu. Higher link quality and speed is recommended for a better user experience. We recommend a wireless AC router with MIMO technology for maximum performance.

### Resetting your system

If your system acts strangely, it can be reset to its default settings by using a paperclip to press the RESET button in the back ( see illustration "rear panel overview") The yellow led will blink a few times, after which the green led will start to blink. The unit will have restarted into the initial setup and you can then follow the steps in this quick start guide. To fully reset the software of the system, please go to Firmware and Software chapter under support on [www.electrocompaniet.com](http://www.electrocompaniet.com) and follow the instructions for software download.

### WI-FI Setup with WAC ( Wireless accessory configuration)

- If airplay speaker is not shown, or my unit does not appear there?

Make sure that the green LED is on. If it is off, press the RESET button. This resets and restarts the unit, and it will be back online in about one minute.

If the LED still not turns on green, please contact support. If the LED is on but the unit still does not appear, please temporarily connect the unit to the network by Ethernet cable, and follow the steps on page 9.



## IR REMOTE CONTROL CODES

RC5 codes are denoted as xx.yy where xx is 5 bit adress and yy is 6 bit command/ data. All numbers are in decimal. RC6 codes are denoted as xxx.yyy. xxx is 8 bit adress. yyy is 8 bit command code. All numbers in decimal. All RC6 codes are mode 0.

Key label	Code Type	Code Hex
MUTE	RC5	10.0D
STANDBY	RC6	EC.0C
DIM	RC6	EC.10
PREV	RC6	EC.21
PLAY	RC6	EC.2C
STOP	RC6	EC.31
NEXT	RC6	EC.20
REPEAT	RC6	EC.1D
SHUFFLE	RC6	EC.1C
VOL UP	RC5	10.10
VOL DOWN	RC5	10.11
CX1	RC6	EC.12
CX2	RC6	EC.13
TL1	RC6	EC.0A
TL2	RC6	EC.0B





## TECHNICAL SPECIFICATIONS ECM 1 MKII

The following technical data were measured on randomized test objects and are typical data. All measurements are made at 120V / 240V // 50Hz / 60Hz.  
Clipping point of the amplifier is set to a level where total harmonic distortion (THD) is 0.2 %.

### Preamplifier section

Noise floor (1Vrms, 20 - 20 kHz, balanced). < -145dB

Frequency response: 0.5 - 48 kHz

THD + N: < 0.0005%

### DAC section

- Upsampling rate: 192 kHz, 24bit
- Digital/Analog Conversion: 192 kHz, 24 bit
- **Input sampling rate:**
  - 2x TosLink SPDIF - 192 kHz, 24 bit
  - 2x Coax SPDIF - 192 kHz, 24 bit

### Streamer section

- Network connection: Wi-Fi or LAN
- Advanced 802.11 AC WiFi with MIMO
- 1x Gigabit Ethernet (1000Mbps)
- 1x USB for external storage
- 1x SPDIF Coax output
- iOS, Android and Web app

### Streaming services

- Airplay
- Spotify Connect
- TIDAL
- Qobuz
- Bluetooth
- Internet Radio
- DLNA as renderer

Internal drive: Docking, self installation .5"/2.5" - unlimited capacity.

Number of channels: 2 ch

### Dimensions

Width: 470 mm - 18.5 inches

Depth: 381 mm - 14.99 inches

Height: 80 mm - 3.14 inches

Weight: 8.3 Kg - 18 lbs \*(without internal drive)

\*Specifications are subject to change without notice.



## IF SERVICE IS NEEDED

Your dealer will have all relevant information regarding the service centers in your area, and will ensure that your unit is serviced with minimum delay. It is our general policy to have your unit returned to you within five working days. This is an average time, and can vary locally, depending on the workload at that particular service station. If, for some reason, there are no service facilities available in your country, contact Electrocompaniet support first. If requested to do so by technical personell, please ship the unit to the following address:

EC Living AS,  
Breivikveien 7,  
N-4120 Tau,  
Norway

Web: [www.electrocompaniet.com](http://www.electrocompaniet.com)

Service department: [support.electrocompaniet.com](mailto:support.electrocompaniet.com)

The end user is responsible for all shipping charges, insurance, re-importation and duty charges.

When shipping a product to the factory for service, always include the following:

1. A sales slip or other proof of purchase if repair is claimed under warranty.
2. A proforma invoice with value of goods, stating that the ECM 1 MKII is returned to Norway for repair.
3. An accompanying letter describing faults, symptoms, or problems with the unit.
4. Always ship the unit in its original carton and packaging material to prevent damage in transit.

Electrocompaniet will not cover damages incurred in transit. If you require further information concerning the operation of the unit, or if you have any questions related to service, please do not hesitate to contact your dealer or your national distributor.

## User Manual Updates Online

An updated version of the User Manual may be available online at the Electrocompaniet web site. Occasional updates are needed to reflect new features added to the player since the User Manual was printed. As future firmware updates bring in new features and functions, the online version of the User Manual will be updated accordingly.

## Copyright Protection

Reverse engineering or disassembly is prohibited. Part of the software is open-sourced under the GPL license. Please contact us for availability.

€

---



ELECTROCOMPANIET

If music *really* matters™

DEALER  
STICKER  
HERE

LOCAL DEALER

### **Warning!**

To avoid risk of fire or electric shock, do not expose this appliance to rain or moisture. Verify line voltage before use. Do not remove cover. No user serviceable parts inside. Refer servicing to qualified service personnel. The warranty is void if the product is tampered by non-authorized personnel. Use only authorized Electrocompaniet service center.

REV 1.1 2019

Designed and manufactured in Norway  
[www.electrocompaniet.com](http://www.electrocompaniet.com)